

**OLYMPUS®**

---

DIGITAL VOICE  
RECORDER  
**DS-2400**

**INSTRUCTIONS**  
**EN INSTRUCTIONS**

Thank you for purchasing an Olympus  
Digital Voice Recorder.

Please read these instructions for information  
about using the product correctly and safely.  
Keep the instructions handy for future reference.

---

To ensure successful recordings, we recommend that  
you test the record function and volume before use.

**EN**

# Introduction

- The contents of this document may be changed in the future without advanced notice. Contact our Customer Support Center for the latest information relating to product names and model numbers.
- The utmost care has been taken to ensure the integrity of the contents of this document. In the unlikely event that a questionable item, error, or omission is found, please contact our Customer Support Center.
- Any liability for passive damages or damage of any kind occurred due to data loss incurred by a defect of the product, repair performed by the third party other than Olympus or an Olympus authorized service station, or any other reasons is excluded from Olympus's liability.

## Trademarks

Microsoft and Windows are registered trademarks of Microsoft Corporation.

Macintosh is a trademark of Apple Inc.

Intel and Pentium are registered trademarks of Intel Corporation.

The SD logo is a trademark.

The SDHC logo is a trademark.

Other product and brand names mentioned herein may be the trademarks or registered trademarks of their respective owners.



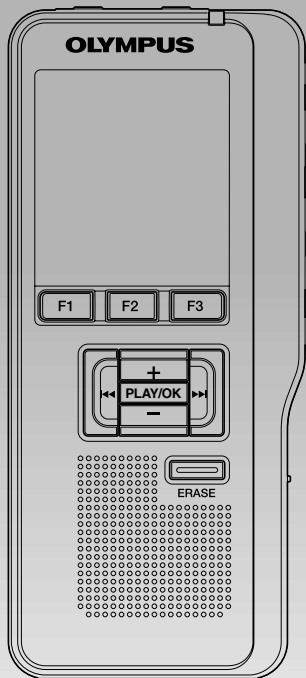

<b>Table of Contents</b>	<b>P.4</b>
<b>Safe and Proper Usage</b>	<b>P.5</b>
<b>Getting Started</b>	<b>P.7</b>
<b>Basic Operations</b>	<b>P.19</b>
<b>Advanced Operations</b>	<b>P.33</b>
<b>Managing Files on Your PC</b>	<b>P.49</b>
<b>Other Practical Use Methods</b>	<b>P.57</b>
<b>Other Information</b>	<b>P.58</b>

- 1**
- 2**
- 3**
- 4**
- 5**
- 6**

# Table of Contents

---

Table of Contents .....	4
Safe and Proper Usage .....	5
General Precautions .....	5

## 1 Getting Started

Main Features .....	7
Memory Card .....	8
Identification of Parts .....	10
Installing Batteries .....	12
Power Supply .....	14
Power Save Mode (Power Save) .....	14
HOLD .....	15
Inserting and Ejecting a SD card .....	16
Setting Time and Date (Time & Date) ...	17

## 2 Basic Operations

Recording .....	19
Microphone Sensitivity (Mic Sense) .....	23
Recording Modes (Rec Mode) .....	24
Using the Variable Control Voice Actuator (VCVA) .....	25
Recording Monitor .....	26
Playing .....	27
Erasing .....	29

## 3 Advanced Operations

Menu List .....	33
Learning to Use the Menu .....	35
Selecting Folders and Files .....	36
Displaying File Information (Information) ....	37
Locking Files (Lock) .....	38

Index Marks .....	39
Language (Language) .....	40
Backlight (Backlight) .....	41
LED (LED) .....	42
LCD Contrast Adjustment (Contrast) ....	43
System Sounds (Beep) .....	44
Formatting the Card (Format) .....	45
Check System Information (System info.) ..	47
Changing the USB Class (USB Class) ....	48

## 4 Managing Files on Your PC

DSS Player Software .....	49
Installing DSS Player Software .....	51
Uninstalling DSS Player Software .....	52
Using Online Help .....	53
Connecting Recorder to PC .....	54
Running DSS Player Software .....	56

## 5 Other Practical Use Methods

Using as External Memory of the Computer ...	57
--	----

## 6 Other Information

Alarm Message List .....	58
Troubleshooting .....	59
Accessories .....	60
Specifications .....	61
Technical Assistance and Support .....	62

# Safe and Proper Usage

---

**Before using your new recorder, read this manual carefully to ensure that you know how to operate it safely and correctly. Keep this manual in an easily accessible location for future reference.**

- The warning symbols indicate important safety related information. To protect yourself and others from personal injury or damage to property, it is essential that you always read the warnings and information provided.

## Convention Used in this Manual

- The word “card” is used to refer to the SD card.
- The word “DSS Player” is used to refer to the DSS Player Standard Dictation Module in Windows environment and DSS Player in Apple Macintosh environment.
- The Notes at the bottom of a page are used for additional information, exceptions, or related events.
- Words in uppercase form such as PLAY or REC are used to describe a function or button on the recorder.

# General Precautions

---

- Do not leave the recorder in hot, humid locations such as inside a closed automobile under direct sunlight or on the beach in the summer.
- Do not store the recorder in places exposed to excessive moisture or dust.
- Do not use organic solvents such as alcohol and lacquer thinner to clean the unit.
- Do not place the recorder on top of or near electric appliances such as TVs or refrigerators.
- Avoid recording or playing back near cellular phones or other wireless equipment, as they may cause interference and noise. If you experience noise, move to another place, or move the recorder further away from such equipment.
- Avoid sand or dirt. These can cause irreparable damage.
- Avoid strong vibrations or shocks.
- Do not disassemble, repair or modify the unit yourself.
- Do not operate the unit while operating a vehicle (such as a bicycle, motorcycle, or go-cart).
- Keep the unit out of the reach of children.

### <Warning regarding data loss>

Recorded content in memory may be destroyed or erased by operating mistakes, unit malfunction, or during repair work.

It is recommended to back up and save important content to other media such as a computer hard disk.

### Batteries

---

#### Danger

- Do not solder lead wires or terminals directly onto a battery or modify it.
- Do not connect the ⊕ and ⊖ terminals together. This may cause fire, overheating or electric shock.
- When carrying or storing the battery, be sure to put it in the provided case to protect its terminals. Do not carry or store the battery with any metal objects (such as key rings). If this warning is not followed, fire, overheating or electric shock may occur.
- Do not connect the batteries directly to a power outlet or a cigarette lighter of an automobile.
- Do not insert the batteries with their ⊕ and ⊖ terminals reversed.
- If any liquid from a battery gets into your eyes, promptly wash it off with clean water and consult your doctor at once.
- There is a hole from which gas escapes on the ⊕ terminal. Do not cover or block it.

#### Warning

- Batteries should never be exposed to flame, heated, short-circuited or disassembled.
- Do not attempt to recharge alkaline, lithium or any other non-rechargeable batteries.

- Never use any battery with a torn or cracked outer cover.
- Keep batteries out of the reach of children.
- If you notice anything unusual when using this product such as abnormal noise, heat, smoke, or a burning odor:
  - ① remove the batteries immediately while being careful not to burn yourself, and;
  - ② call your dealer or local Olympus representative for service.
- Do not expose the batteries to water. Do not allow water to contact the terminals.
- Do not remove or damage the battery insulating sheet.
- Do not use the batteries if you find something wrong with them such as leakage, color change or deformity.
- Should any battery liquid get on skin or clothing, promptly wash it off with clean water.
- Keep batteries away from fire.

#### Caution

- Do not subject batteries to strong shocks.
- Do not use batteries of different types, voltages, and/or brand names.

# 1 Getting Started

## Main Features

---

- Support type of memory: SD card (☞ P.8).
- Three smart buttons F1,F2 and F3.
- Recording and storing voice in Digital Speech Standard Pro (DS2 format).
- Two recording modes, QP (Quality Playback) mode or SP (Standard Playback) mode (☞ P.24).
- Overwrite Recording and Insert Recording (partial insertion) available (☞ P.21, 22).
- Supports USB 2.0. High-Speed, which enables high-speed data transmission from the recorder to your computer.
- Five folders and up to 200 files/folder, for a maximum of 1000 recordings (☞ P.19).
- It has a built-in Variable Control Voice Actuator (VCVA) function (☞ P.25).
- Large LCD screen with backlight.
- Index mark function which is useful to search particular points in the dictation (☞ P.39).
- DSS Player software included (☞ P.49).

# Memory Card

This recorder uses memory in the form of SD card memory.

## Compatible Cards

The recorder supports cards with memory capacity between 512 MB to 16 GB.

### Settings and operating environment relating to the card

Check the latest operating information on the Olympus homepage (<http://www.olympus.com>) when using cards other than the included card. In addition, refer to the following pages as well when handling the card.

- Inserting and Ejecting a SD card (P.16)
- Formatting the Card (Format) (P.45)

### SD card

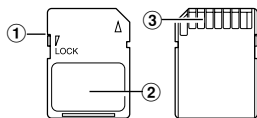

### SD card

#### ① Card Lock

SD card is equipped with a lock function. When the lock function is used, important data is protected by preventing it from being accidentally overwritten or erased.

When the lock function is set  will appear on the display.

#### ② Index Area

For writing down information identifying card or content.

#### ③ Contact Area

Comes into contact with the recorder's signal read contacts.

## Memory Sizes of Cards and Approximate Recording Times\*1

Memory Size	QP Mode	SP Mode
512MB	38 hr. 30 min.	79 hr. 00 min.
1GB	77 hr. 00 min.	157 hr. 50 min.*2
2GB	152 hr. 30 min.*2	312 hr. 20 min.*2
4GB	305 hr. 50 min.*2	626 hr. 50 min.*2
8GB	624 hr. 30 min.*2	1279 hr. 30 min.*2
16GB	1248 hr. 10 min.*2	2557 hr. 10 min.*2

The above are the standard times, and the available recording time will vary depending on the card.

\*1: Available recording time for one continuous file.

Available recording time may be shorter if many short recordings are made.

\*2: Total recording time of several files. The maximum recording time per file is 99 hours 59 minutes.

**⚠ Warning**

- Do not touch the card contacts. That may damage the card.



- Do not place the card in locations with static electricity.



- Store the card in a location that is out of the reach of children. In case of accidental ingestion, consult a physician immediately.

**Check Card Information (Card Info.)**

Information such as the memory capacity and remaining memory for installed cards can be displayed on the recorder (☞ P.34).

Card Info.	
SD	
Remain	540MB
Capacity	1.0GB
BACK	EXIT

**Notes**

- When initializing (formatting) a card, confirm that no necessary data is stored on the memory card beforehand. Initialization completely erases the existing data on the card.
- In some cases cards which have been formatted (initialized) by another device, such as a computer, cannot be recognized. Be sure to format them with this recorder before using.
- The card has a service life. When reaching the end of its life, writing or erasing data on the card will be disabled. In this case, replace the card.
- If you use a PC card adapter compatible with the card to save or delete some data on the card, the maximum recording time on the card may be decreased. To recover the original recording time, initialize/format the card in the recorder.
- Olympus will not be held liable for any data corruption or loss due to misuse of the media card.

# Identification of Parts

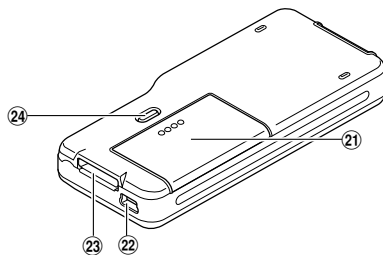
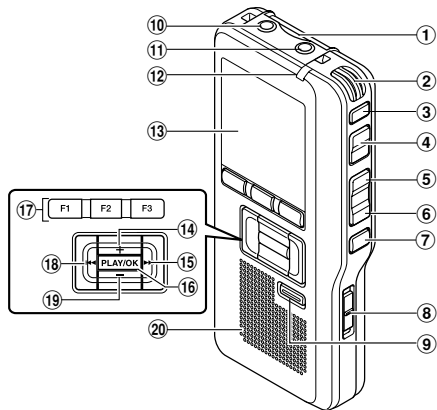

- ① SD card slot
- ② Built-in microphone
- ③ NEW button
- ④ REC button
- ⑤ REW button
- ⑥ FF button
- ⑦ STOP button
- ⑧ POWER/HOLD switch
- ⑨ ERASE button
- ⑩ EAR (Earphone)
- ⑪ MIC (Microphone)
- ⑫ Record indicator light
- ⑬ Display (LCD panel)
- ⑭ + (Volume) button
- ⑮ Fast Forward (▶▶) button
- ⑯ PLAY/OK button
- ⑰ Smart button (F1,F2,F3)
- ⑱ Rewind (◀◀) button
- ⑲ - (Volume) button
- ⑳ Built-in speaker
- ㉑ Battery cover
- ㉒ PC (USB) terminal
- ㉓ Cradle connector
- ㉔ Battery cover release button

## Display Status Indicators

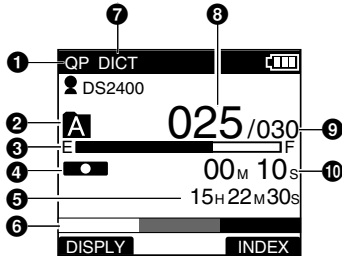

Display in the recording mode

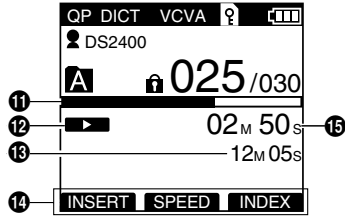

Display in the playback mode

- ❶ Record mode indicator
- ❷ Current folder
- ❸ Memory remaining indicator (E/F bar)
- ❹ Record indicator
- ❺ Remaining recording time
- ❻ Level meter indicator
- ❼ Microphone sensitivity indicator
- ❽ Current file number

- ❾ Total number of files in the folder
- ❿ Recording elapsed time
- ⓫ Playback position bar indicator
- ⓬ Play indicator
- ⓭ Total recording time of the selected file
- ⓮ Button guide display
- ⓯ Current Playback time

- 👤 Author ID indicator
- 🔋 Battery indicator
- VCVA VCVA (Variable Control Voice Actuator) indicator

- 🔒 Card Lock indicator
- 🔒 Erase Lock indicator

# Installing Batteries

This recorder can be used with AAA Alkaline Batteries.

- 1 Lightly press down on the battery cover release button, then open the battery cover.

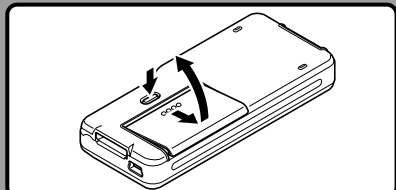

- 2 Insert two AAA batteries, observing the correct polarity as shown in the illustration below, then close the battery cover.

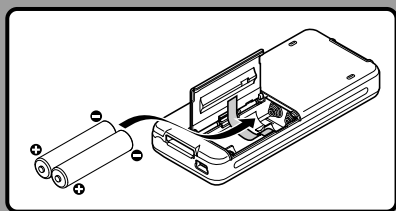



Insert the batteries in the direction inscribed on the inside of the recorder's battery compartment. In addition, when inserting the batteries, insert them so that the tape is under the batteries, as shown in the illustration. The batteries can then be removed easily by pulling up the tape. **When pulling on the tape the batteries may suddenly pop out, so be sure to press down lightly on the batteries with your finger while pulling.**

## Recharging Battery Pack

The battery indicator on the display changes as the batteries lose power.



When  appears on the display, replace the batteries as soon as possible.

When the batteries are too weak, the recorder shuts down and [  Battery Low ] appears on the display.

## Cautions Concerning the Battery

### ⚠ Warning



- Using batteries for which part or all of the external coating (insulating sheath) is peeling off or batteries which have ruptured may cause fluid leaks, overheating, and explosions. For this reason such batteries should absolutely not be used.



- Commercially available batteries for which part or all of the external coating (insulation sheath) has been peeled off should absolutely not be used.

### Unusable batteries

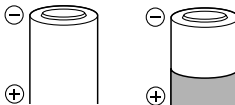

Batteries for which the entire external coating (insulating sheath) is peeled off (naked batteries), or those where it has partially been peeled off.

### Notes

- **Be sure to turn OFF the recorder before replacing the batteries.** Removing the batteries while the recorder is in use may corrupt the card. If you are recording into a file and the batteries run out, you will lose your currently recorded file since the file header will not be written. It is crucial to replace the batteries when one hash mark is shown in the battery icon.
- Be sure to replace both batteries at the same time.
- **Never mix old and new batteries, or batteries of different types and/or brands.**
- If it takes longer than 1 minute to replace dead batteries, you may have to reset the time when you load new batteries.
- Remove the batteries if you are not going to use the recorder for an extended period of time.

# Power Supply

When the recorder is not being used, turn the power off to reduce battery consumption to a minimum. Even if the power is turned off, existing data, mode settings, and clock settings will be maintained.

## Turning On the Power

While the recorder's power is off, slide the **POWER/HOLD** switch in the direction indicated by the arrow.

The display will turn on, and after [System Check] appears, the power will be turned on. The resume function will bring the recorder back to the stop position in memory before power was turned off.

## Turning Off the Power

Slide the **POWER/HOLD** switch in the direction indicated by the arrow for 0.5 seconds or longer.

The display shuts off and the power will be turned off. The resume function remembers the stop position before the power is turned off.

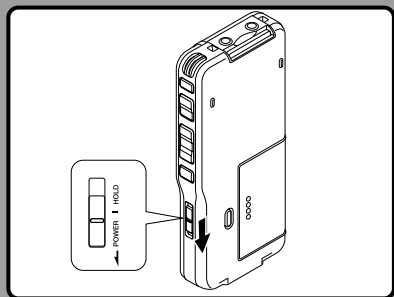

# Power Save Mode (Power Save)

When the recorder is ON but not in use for 10 minutes, by default, it will switch to power save mode automatically. To reactivate the recorder again, operate any button or the slide switch.

## Power Save Setting

You can set the time to enter Power Save mode from among [5 minutes.], [10 minutes.], [30 minutes.], [1 hour], and [Off]. To exit power save, press any button. The [Power Save] setting can be changed from the Menu. For more details, refer to "Menu List" (P.33) and "Learning to Use the Menu" (P.35).

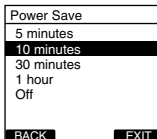

# HOLD

If you bring the POWER/HOLD switch to the HOLD position, the current conditions will be preserved, and all buttons and switches will be disabled. This feature is useful when the recorder has to be carried in a bag or pocket.

## Set the recorder to HOLD mode

Slide the **POWER/HOLD** switch to the **HOLD** position.

After [Hold] appears on the display, the recorder is set to HOLD mode.

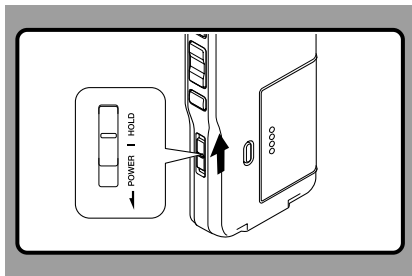

## Exit HOLD mode

Slide the **POWER/HOLD** switch to the **(A)** position.

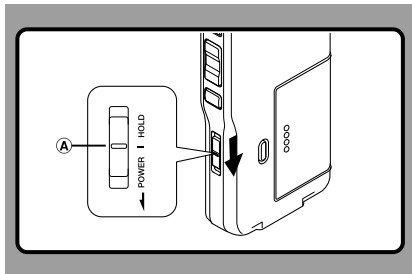

# Inserting and Ejecting a SD card

## Inserting a SD card

Insert the SD card into the card slot in the direction shown in the illustration until it clicks.

When inserting SD card into the SD card slot, the recorder message [Please Wait] will flash on the LCD display for a few seconds while validating the SD card.

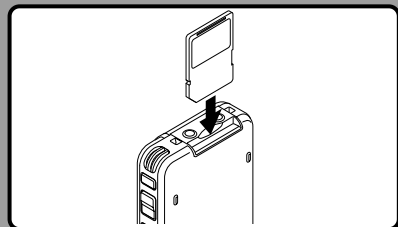

## Ejecting a SD card

Push the SD card inward once to unlock it, and let it eject.

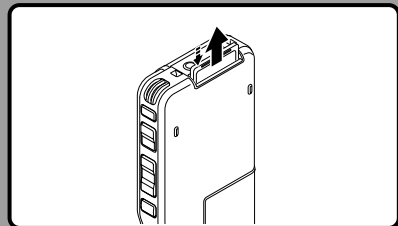

## Notes

- Insert the card keeping it straight.
- The card stops with a click when it is inserted all the way.
- Inserting the card the wrong way or at an angle could damage the contact area or cause the card to jam.
- If the card is not inserted all the way, data may not be written to the card.
- Hold the card straight and pull it out.
- If an unformatted card is installed, the recorder will automatically display the menu format option (☞ P.45).
- Never use any card in the recorder unless it has been formatted on this unit (☞ P.45).
- Never remove the card while the recorder is in operation. This may damage the data.
- Releasing your finger quickly after pushing the card inward may cause it to eject forcefully out of the slot.

# Setting Time and Date (Time & Date)

Setting the correct time and date on the recorder is very important since every file recorded on the recorder will have the time and date information as part of the file header. This will simplify the file management aspects later on.

**The hour indicator will flash automatically when you load batteries before using the recorder for the first time, or after the recorder has not been used for a long time.**

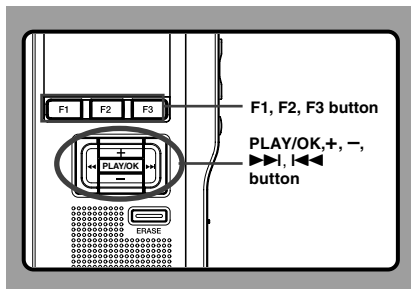

## 1 Press the >>> or <<< button to select the item to set.

Select the item from "hour", "minute", "year", "month" and "day" with a flashing point.

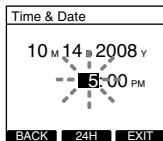

## 2 Press the + or - button to set.

Follow the same steps by pressing the >>> or <<< button to select the next item, and press the + or - button to set.

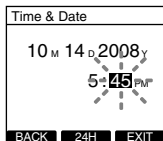

- You can choose between 12 and 24 hour display by pressing the F2(24H or 12H)\* button while setting the hour and minute.

Example: 5:45 P.M.

5:45 PM (Initial setting) ↔ 17:45

## Setting Time and Date (Time & Date)

- You can choose the order of the year, month, day by pressing the F2(D/M/Y or Y/M/D or M/D/Y)\* button while setting them.  
Example: October 14, 2008

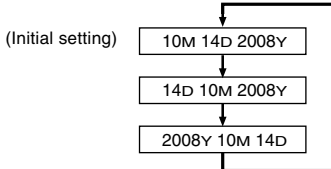

\*The display will vary depending on the status of the settings.

### 3 Press the **PLAY/OK** button to complete the setup screen.

The clock will start from the set date and time. Press the PLAY/OK button according to the time signal.

### Notes

- If you press the STOP button during the setup operation, the settings are cancelled, and the recorder returns to the previous screen.
- You can set the time and date from your PC using DSS Player software (☞ P.50).

## Changing the Time and Date

When the recorder's POWER/HOLD switch is turned ON the [Time & Date] will be displayed for two seconds. If the time and date is not correct, set it using the procedure below.

- 1 Press the **+** or **-** button in the [Device Menu] screen, then select [Time & Date]. See P.34 regarding the menu.

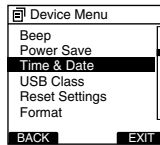

- 2 Press the **PLAY/OK** or **▶▶** button.  
The time and date screen appears. The hour indicator flashes, indicating the start of the time and date setup process. The following steps are the same as Step 1 through Step 3 of "Setting Time and Date (Time & Date)" (☞ P.17).
- 3 Press the **F3(EXIT)** or **◀◀** button to complete the setting.

# 2 Basic Operations

## Recording

The recorder has five folders, A, B, C, D, E and you can select folder by pressing the F1 (FOLDER) button. These five folders can be selectively used to distinguish the kind of recording; for example, Folder A might be used to store private information, while Folder B might be dedicated to holding business information. Up to 200 messages can be recorded per folder.

By default, the Recording Mode is QP.

### Record Function

By default, the RECORD function is configured to record at the current position (overwrite). However, that can be changed to any of the following settings:

- Append: Appends the recording to the end of the current file (☞ P.20).
- Overwrite: Overwrites the recording starting at the current position in the file (☞ P.21).
- Insert: Inserts the recording at the current position in the file (☞ P.22).

### Recording Related Settings

Recording related settings can be configured to provide a suitable recording environment.

- Microphone Sensitivity (Mic Sense) (☞ P.23)
- Recording Modes (Rec Mode) (☞ P.24)
- Using the Variable Control Voice Actuator (VCVA) (☞ P.25)
- Recording Monitor (☞ P.26)

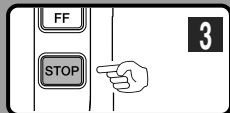
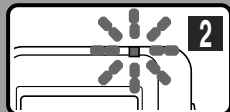
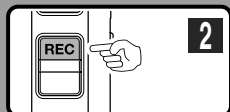
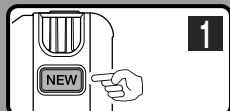

## New Recording

Create a new file to record in.

### 1 Press the **NEW** button to create a new file.

- a Selected Author ID
- b New file number
- c Remaining recording time

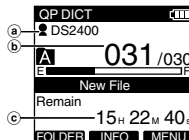

### 2 Press the **REC** button to start recording.

The record indicator light glows orange and  (Record indicator) appears on the display.

Aim the microphone at the sound source. When you press the F1 (DISPLY) button during recording, you can change the LCD screen displays.

- d Record indicator

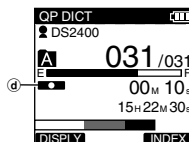

### 3 Press the **STOP** button to stop recording.

If you want to append additional recordings to the same file, press the REC button again.



## Notes

- A beep will sound when the remaining recording time reaches 60 seconds, 30 seconds, and 10 seconds while recording.
- When remaining recording time is less than 60 seconds, the record indicator light starts flashing in orange. When the recording time is decreasing to 30 or 10 seconds, the light flashes faster.
- [Memory Full] or [Folder Full] will be displayed when the memory or folder capacity is full.
  - Delete any unnecessary files before recording any further (P.29) or transfer dictation files to your computer using DSS Player Software (P.49).

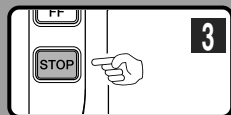
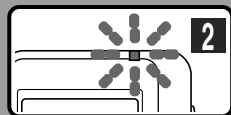
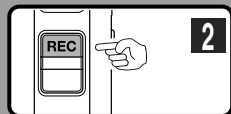

## Overwrite Recording

You can overwrite a previously recorded file from any point within the file.

Note that the overwritten recordings will be erased.

### 1 Select and play the file you want to overwrite.

Stop playback at the starting point of overwrite.

### 2 Press the **REC** button to start overwriting.

The record indicator light glows orange and  (Record indicator) appears on the display.

- Ⓐ Recording elapsed time
- Ⓑ Total recording time of the selected file

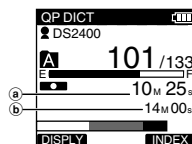

### 3 Press the **STOP** button to stop overwriting.

#### Note

- You cannot select a different recording mode (QP, SP) than that of the original file before overwrite recording.

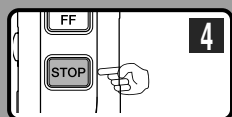
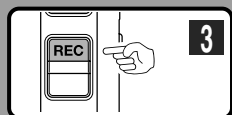
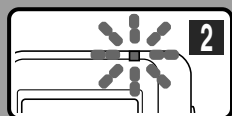
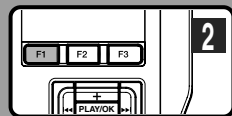
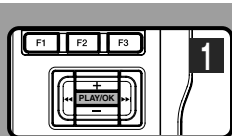

## Insert Recording

Additional recording can be inserted into previously recorded file.

**1** Select and play the file you want to insert an additional recording into.

**2** While playing the file, press the **F1 (INSERT)** button to insert an additional recording.  
[Insert Rec?] appears on the display.

**3** Press the **REC** button to start inserting an additional recording.

The record indicator light glows orange and  (Record indicator) appears on the display.  
[Insert Rec] and the remaining recording time will alternate on the display.

**4** Press the **STOP** button to stop inserting the additional recording.

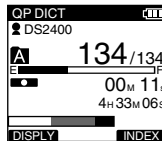

### Notes

- The recording time and date of the file is updated to the time and date of the inserted recording.
- You cannot select a different recording mode (QP, SP) than that of the original file before inserting.

# Microphone Sensitivity (Mic Sense)

You can switch between two microphone sensitivities to meet recording needs: [Dictation] for oral dictation and [Conference] which is suited for situations like meetings and conferences with a small number of people. The setting status will appear on the display as **CONF** or **DICT**.

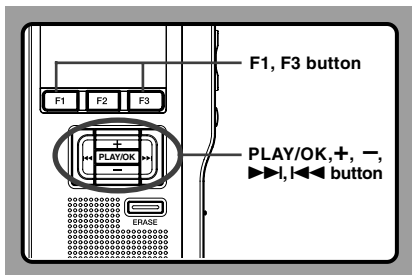

1 Select **[Mic Sense]** at the **[Record Menu]** screen, then press the **PLAY/OK** or **>>>** button.

Refer to P.33 regarding each menu item settings.

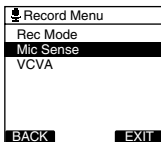

2 Press the **+** or **-** button to select **[Conference]** or **[Dictation]**.

**Conference...**High-sensitivity mode that records sounds in all directions.

**Dictation...**Low-sensitivity mode suited for dictation.

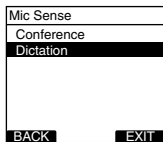

3 Press the **PLAY/OK** button to complete the setup screen.

[Conference Set] or [Dictation Set] will light up on the display, and it will return to the [Record Menu] screen.

If you press the **<<<** or **F1(BACK)** button the setting will be cancelled and it will return to the [Record Menu].

Pressing the **F3(EXIT)** button will cancel the contents being set and take you out of the MENU.

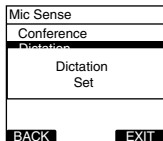

4 Press the **F3(EXIT)** or **<<<** button to complete the setting.



# Recording Modes (Rec Mode)

The recording mode can choose between QP (Quality Playback) and SP (Standard Playback).

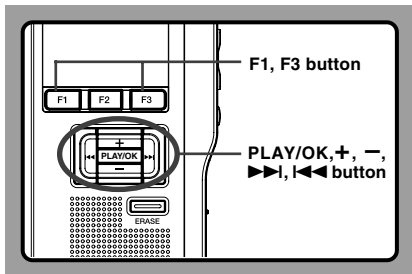

- 1 Select [Rec Mode] at the [Record Menu] screen, then press the **PLAY/OK** or **▶▶** button.

Refer to P.33 regarding each menu item settings.

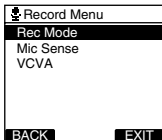

- 2 Press the **+** or **-** button to select [QP] or [SP].

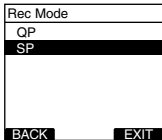

- 3 Press the **PLAY/OK** button to complete the setup screen.

[QP Set] or [SP Set] will light up on the display, and it will return to the [Record Menu] screen.

If you press the **◀◀** or F1(BACK) button the setting will be cancelled and it will return to the [Record Menu].

Pressing the F3(EXIT) button will cancel the contents being set and take you out of the MENU.

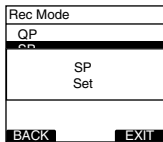

- 4 Press the **F3(EXIT)** or **◀◀** button to complete the setting.

Set Recording Mode is displayed when creating the New File and during recording.

The recording mode of file recording is displayed during playback and in stop mode.



## Note

- Choose QP mode for recording meetings or lectures with crisp clarity.

# Using the Variable Control Voice Actuator (VCVA)

The Variable Control Voice Actuator (VCVA) is a function that starts recording automatically when the microphone senses that sounds have reached a preset threshold volume level, and automatically pauses when the volume drops below the threshold. The VCVA feature allows you to conserve memory by automatically stopping recording in instances like long silent periods during meetings.

When this is enabled, **VCVA** will appear on the display.

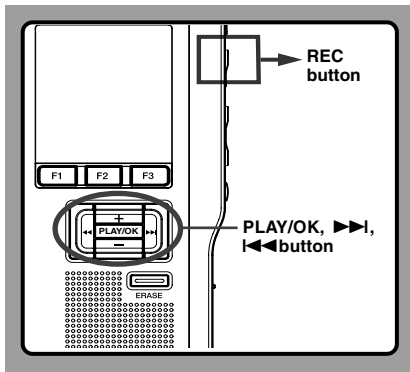

- 1 **Set the VCVA in the menu to [On].**  
Refer to P.33 regarding each menu item settings.

- 2 **Press the REC button to start recording.**  
When the sound volume is lower than the preset actuation sound level, recording automatically stops after 1 second approximately, and "Stand by" flashes on the display. The record indicator light glows orange and  (Record indicator) appears when recording starts and flashes when recording pauses.

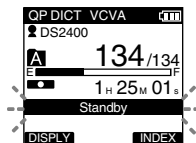

## Adjust the Start/Stop Actuation Level

While the recorder is in recording mode, press the **>>>** or **<<<** button to adjust the actuation level.

The VCVA level can be set to any of 15 different values. The higher the value is, the more sensitive the recorder can react to sounds. At the highest value, even the faintest sound will activate recording.

The VCVA actuation level can be adjusted according to the ambient (background) noise.

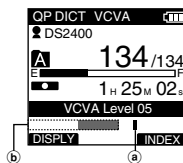

- a **Start level**  
(Varies according to the sound volume being recorded)
- b **Level meter indicator** (moves to the left/right according to the set level)

## Notes

- The start/stop actuation level also varies depending on the selected microphone sensitivity mode (P.23).
- To ensure successful recordings, prior testing and adjustment of the start/stop actuation level is recommended.
- If the recorder detects an input that exceeds the Start level, the dotted line of the Level meter indicator will change to the full line, and the recorder starts recording.

# Recording Monitor

---

It is possible to monitor your recording by listening to the recording while recording is in progress. Insert the earphone plug into the earphone jack and use the + or – button to control the volume level.

## 2 Recording Monitor

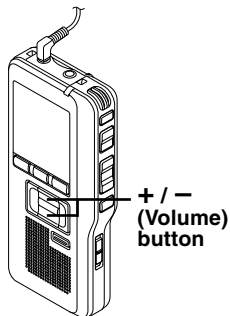

---

### Note

- Insert the plugs in to the end as shown in the illustration when inserting the earphone or external microphone.

# Playing

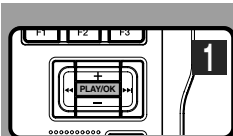

You can start playing a file at any point.

## 1 Select the file, then press the **PLAY/OK** button to start playback.

The  (Play indicator) appears on the display.

Ⓐ Play indicator

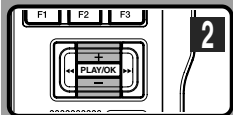

## 2 Press the **+** or **-** button to adjust the volume.

The display shows the volume level. You can choose between 0 to 30.

Ⓑ Volume level

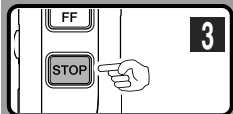

## 3 Press the **STOP** button at any point you want to stop the playback.

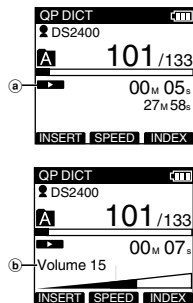

Playback functions	Operation	How to Cancel
<b>Fast Forward (FF)</b>	Press the <b>▶▶</b> or <b>FF</b> button once while stopped.	Press the <b>PLAY/OK</b> or <b>STOP</b> button.
<b>Rewind (REW)</b>	Press the <b>◀◀</b> or <b>REW</b> button once while stopped.	Press the <b>PLAY/OK</b> or <b>STOP</b> button.
<b>Cue (CUE)</b>	Press and Hold the <b>▶▶</b> or <b>FF</b> button while stopped or playing a file.	Release the button.
<b>Review (REV)</b>	Press and Hold the <b>◀◀</b> or <b>REW</b> button while stopped or playing a file.	Release the button.
<b>Playback Speed</b>	<p>Press the <b>F2 (SPEED)</b> button during playback.</p> <p>➤ Every time the <b>F2(SPEED)</b> button is pressed, the playback speed will switch.</p> <p><b>Play(playback):</b> Playback at normal speed.</p> <p><b>Slow Play (slow playback):</b> Playback speed slows down (-50%), and “Slow play” will turn on.</p> <p><b>Fast Play (fast playback):</b> Playback speed becomes faster (+50%), and “Fast play” will turn on.</p>	

### Notes

- If you press the **▶▶** or **FF** button once while fast-forwarding or twice while stopped, the recorder will stop at the end of the file (F.Skip).
- If you press the **◀◀** or **REW** button once while rewinding or twice while stopped, the recorder will stop at the beginning of the file (B.Skip). If the **◀◀** or **REW** button is pressed within 2 seconds, the recorder skips to the beginning of the previous file.

# Erasing

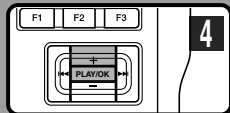
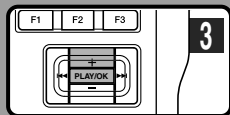
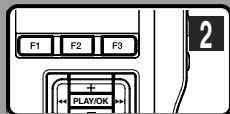

## Erasing a File

Erasing or deleting a file from any of the folder on the recorder is a very simple process.

1 Select the file you want to erase.

2 Press the **ERASE** button.

3 Press the **+** button to select [**File Erase**], then press the **PLAY/OK** button.

4 Press the **+** button to select [**Start**], then press the **PLAY/OK** button.

The display changes to [File Erase !] and erasing will start.

[Erase Done] is displayed when the file is erased. File numbers will be reassigned automatically.

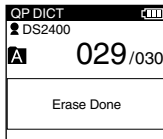
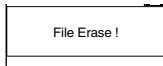
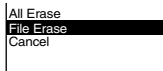
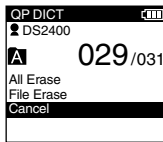

2

Erasing

### Notes

- An erased file cannot be restored.
- Files cannot be erased in the following cases.
  - File being set [Lock] (☞ P.38).
  - The SD card lock is turned on (☞ P.8).

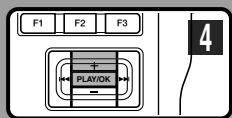
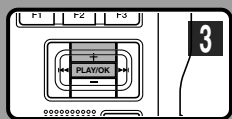
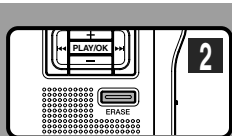

## Erasing All Files in a Folder

All files in a folder can be erased simultaneously.

- 1 Select the folder you want to erase.
- 2 Press the **ERASE** button.
- 3 Press the **+** button to select **[All Erase]**, then press the **PLAY/OK** button.
- 4 Press the **+** button to select **[Start]**, then press the **PLAY/OK** button.  
The display changes to **[All Erase !]** and erasing will start.

[Erase Done] is displayed when the files are erased. Any locked files in the folder will be reassigned new file numbers in ascending order.

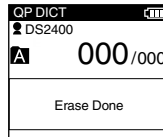
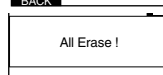
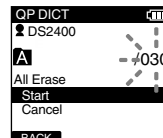
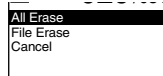
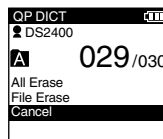

### Notes

- The erasing process may take up to 10 seconds. Do not interrupt this process! Data will be destroyed.
- Files cannot be erased in the following cases.
  - File being set [Lock] (P.38).
  - The SD card lock is turned on (P.8).

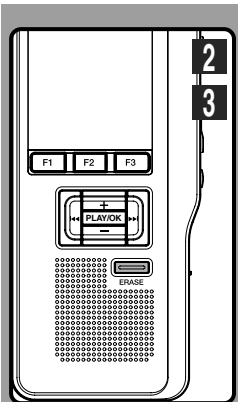

## Partially Erasing a File

You can erase a selected file in part.

**1 Start playback for the file you want to erase partially.**

**2 Press the ERASE button at the point to start erasing.**

While playback continues, [Partial Erase] will appear on the display.

**3 Press the ERASE button at the point to end erasing.**

The erase starting point (time) set in step 2 and the ending point (time) set in this step will alternate on the display for 8 seconds.

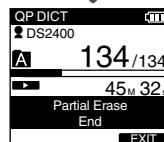
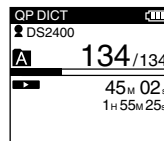

2

Erasing

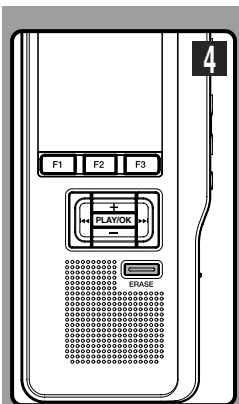

#### 4 Press the **ERASE** button to confirm erase.

The display changes to [Partial Erase!] and erasing will start.

When [Erase Done] appears on the display, partial erase is complete.

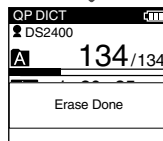
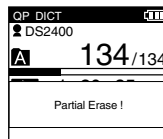



#### Notes

- If the ERASE button is not pressed within 8 seconds after the “Partial Erase Start” and “Partial Erase End” are alternately displayed, the recorder will revert to stop status.
- An erased file cannot be restored.
- Files cannot be Partial erased in the following cases.
  - File being set [Lock] (☞ P.38).
  - The SD card lock is turned on (☞ P.8).

# 3 Advanced Operations

## Menu List

● Menu Setting (while the recorder is stopped, press the **F3(MENU)** button)

Main Menu	Second layer	Setting	Ref. Page
 <b>File Menu</b>	<b>Lock</b>	<b>Off, On</b>	P.38
	<b>Information</b>	The file information is displayed.	P.37
 <b>Record Menu</b>	<b>Rec Mode</b>	<b>QP, SP</b>	P.24
	<b>Mic Sense</b>	<b>Dictation, Conference</b>	P.23
	<b>VCVA</b>	<b>Off, On</b>	P.25
 <b>Display Menu</b>	<b>Backlight</b>	<b>On, Off</b>	P.41
	<b>Contrast</b>	Program contrast level 1~12 (Default is <b>6</b> ).	P.43
	<b>LED</b>	<b>On, Off</b>	P.42
	<b>Language</b>	<b>English, Deutsch, Français, Español, Italiano, Русском</b>	P.32
Device Menu (To the next page)			

Main Menu	Second layer	Setting	Ref. Page
 <p>Device Menu</p>	Beep	<b>On, Off</b>	P.44
	Power Save	In order of 5 minutes, <b>10 minutes</b> , 30 minutes, 1 hour and Off.	P.14
	Time & Date	In order of hour, minute, year, month and day.	P.17
	USB Class	<b>Composite</b> , Storage	P.48
	Reset Settings	Returns the menu settings to their initial state.	P.46
	Format	Initializes the card.	P.45
	Card Info.	Remain, Capacity	P.9
	System Info.	Model Name, Version, Serial	P.47
File Menu (To the page 33)			

## Notes

- The selectable language varies depending on the countries where the product was purchased.
- Items appear in bold letters in the "Setting" column to indicate that they are the initial settings.

# Learning to Use the Menu

To navigate through the different options in the Menu, use the Menu List flow chart (P.33, 34) and the following steps to modify or change any settings.

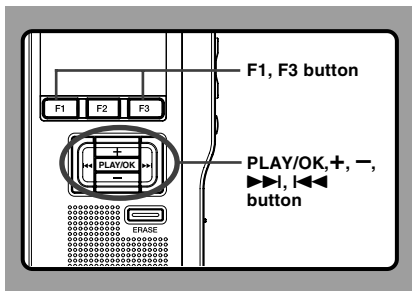

- 1 Press the F3(MENU) button.**  
The [Main Menu] screen will appear on the display (P.33).

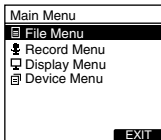

- 2 Press the + or - button to move to [Main Menu] item to be set.**

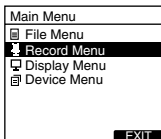

- 3 Press the PLAY/OK or >>> button.**  
Move to the setting of the selected menu items.

- 4 Press the + or - button to move to the menu item to be set.**

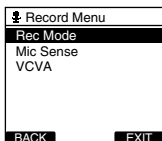

- 5 Press the PLAY/OK or >>> button.**  
Move to the setting of the selected item.

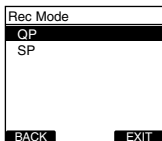

- 6 Press the + or - button to change the setting.**

- 7 Press the PLAY/OK button to complete the setup screen.**

If you press the <<< or F1(BACK) button, the setting will be cancelled and it will return to the menu.

Pressing the F3(EXIT) button will cancel the contents being set and take you out of the MENU.

- 8 Press the F3(EXIT) or <<< button to complete the setting.**

# Selecting Folders and Files

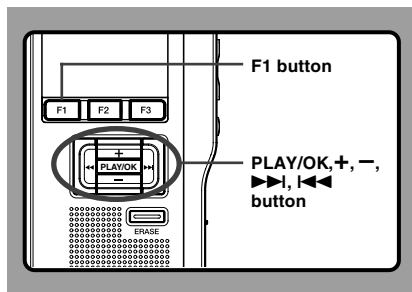

## Changing File

- 1 While the file is being displayed, press the **>>>** or **<<<** button.

This will change and display the file number order for files within the folder.

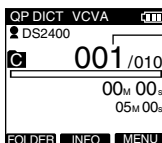

- a Current file number
- b Total number of recorded files in the folder

## Changing Folders

- 1 While the recorder is stopped, press the **F1 (FOLDER)** button.

The folder list screen will be displayed.

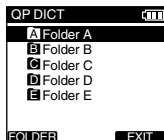

- 2 Press the **+** or **-** button to select the folder, then press the **PLAY/OK** button.

This will change the folder.  
You can switch folders by pressing the F1 (FOLDER) button.

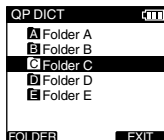

# Displaying File Information (Information)

The recorder can display a variety of information related to the current file.

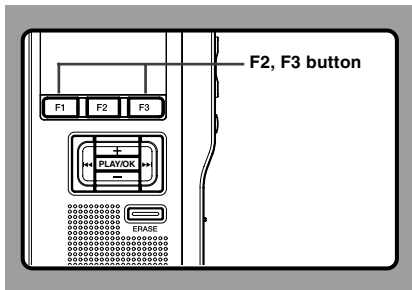

## 1 Select the file whose information you want to display.

Refer to P.36 regarding file selection.



## 2 Press the F2(INFO) button.

The file information is displayed.  
You can display the file information by pressing the F3 (MENU) button and selecting [Information] from [File Menu].

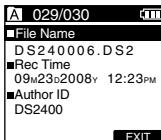

## The Displayed Information

The following information will be displayed.

- [File Name]...File name
- [Rec Time]...Time and date the file was recorded.
- [Author ID]...Display the Author ID of file.

## Note

- When the file that Work Type or the Option Item is set is transferred from PC to this unit, the information will be displayed on the File Information.

# Locking Files (Lock)

When a file is set to [Lock],  will appear on the display, allowing you to prevent important files from accidental erase. Furthermore, the file will not be erased even when all files within a folder are erased.

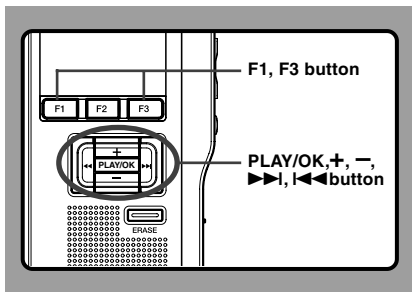

- 1 Select the file you want to Lock.
- 2 Select [Lock] at the [File Menu] screen, then press the **PLAY/OK** or **>>>** button.  
Refer to P.33 regarding each menu item settings.

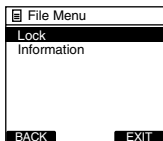

- 3 Press the **+** or **-** button to select [On] or [Off].  
**On...**Locks the file and prevents it from being erased.  
 appears on the display.  
**Off...**Unlocks the file and allows it to be erased.

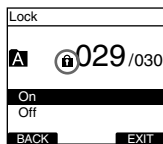

- 4 Press the **PLAY/OK** button to complete the setup screen.  
[File Lock On] or [File Lock Off] will light up on the display, and it will return to the [File Menu] screen.  
If you press the **<<<** or **F1 (BACK)** button the setting will be cancelled and it will return to the [File Menu]. Pressing the **F3 (EXIT)** button will cancel the contents being set and take you out of the MENU.

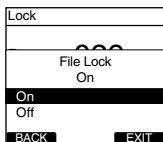

- 5 Press the **F3 (EXIT)** or **<<<** button to complete the setting.



# Index Marks

Index marks can be placed in a file during recording or playback. Index marks are used to provide a quick and easy way to identify important or significant parts within the file.

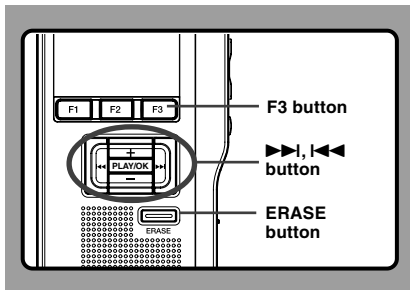

## Setting an Index Mark

- 1 While the recorder is recording or in playback mode, press the **F3 (INDEX)** button to set an Index mark. An index number appears on the display.

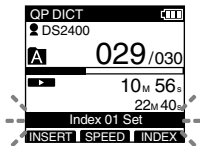

## Locating an Index Mark

- 2 While playing back a file, press and hold the **▶▶** or **◀◀** button. The recorder stops for 1 second when it reaches the Index mark.

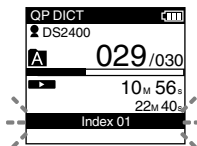

## Clearing an Index Mark

- 3 Locate the Index mark you want to clear.
- 4 While the index number appears for approximately 2 seconds on the display, press the **ERASE** button. The Index mark is erased.



## Notes

- Up to 32 Index marks can be set in a file.
- When a file is locked or set to read-only, or when the SD card lock is enabled Index mark cannot be erased. Clear the settings before erasing.

# Language (Language)

You can select the display language for this recorder.

The selectable language varies depending on the countries where the product was purchased.

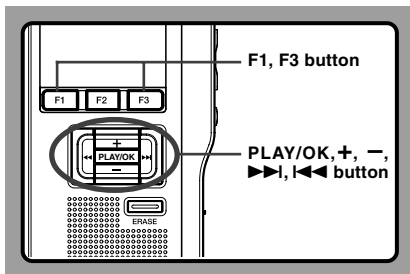

- 1 Select [Language] at the [Display Menu] screen, then press the **PLAY/OK** or **>>>** button.

Refer to P.33 regarding each menu item settings.

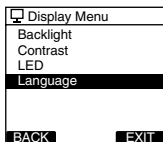

- 2 Press the **+** or **-** button to set the language.

**English...**Displays in English.  
**Deutsch...**Displays in German.  
**Français...**Displays in French.  
**Español...**Displays in Spanish.  
**Italiano...**Displays in Italian.  
**Русском...**Displays in Russian.

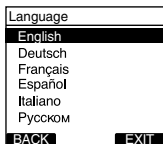

- 3 Press the **PLAY/OK** button to complete the setup screen.

The displayed language is changed and will return to the [Display Menu] screen.

If you press the **<<<** or **F1(BACK)** button the setting will be cancelled and it will return to the [Display Menu].

Pressing the **F3(EXIT)** button will cancel the contents being set and take you out of the MENU.

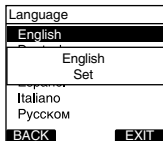

- 4 Press the **F3(EXIT)** or **<<<** button to complete the setting.

## Note

- The selectable language varies depending on the countries where the product was purchased.

# Backlight (Backlight)

When the display backlight is set to [On], the backlight will light up for about 10 seconds when a button is pressed.

This is useful in that it allows you to check the display even in dark locations.

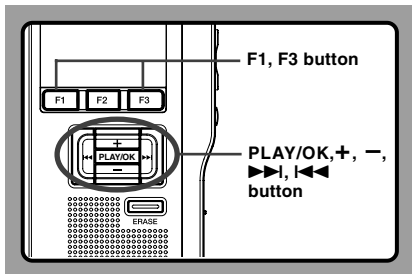

- 1 Select **[Backlight]** at the **[Display Menu]** screen, then press the **PLAY/OK** or **>>>** button.

Refer to P.33 regarding each menu item settings.

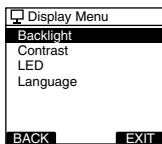

- 2 Press the **+** or **-** button to select **[On]** or **[Off]**.

**On...**Backlight is enabled.  
**Off...**Backlight is disabled.

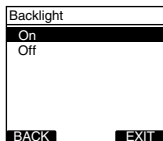

- 3 Press the **PLAY/OK** button to complete the setup screen.

[On.Set] or [Off.Set] will light up on the display, and it will return to the [Display Menu] screen.

If you press the **<<<** or **F1(BACK)** button the setting will be cancelled and it will return to the [Display Menu].

Pressing the **F3(EXIT)** button will cancel the contents being set and take you out of the MENU.

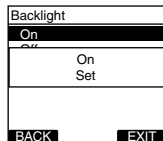

- 4 Press the **F3(EXIT)** or **<<<** button to complete the setting.

# LED (LED)

You can set it so the Record indicator light does not turn on.

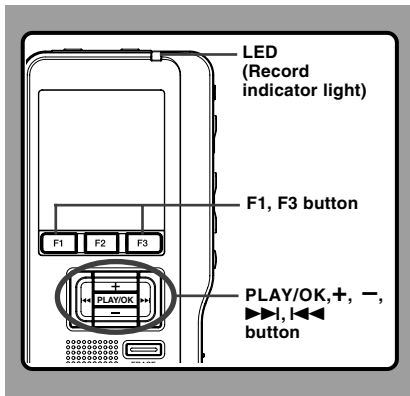

- 1 Select [LED] at the [Display Menu] screen, then press the **PLAY/OK** or **>>>|** button.

Refer to P.33 regarding each menu item settings.

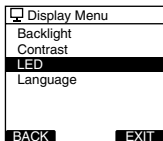

- 2 Press the **+** or **-** button to select **[On]** or **[Off]**.

**On...**LED light will be set.

**Off...**LED light will be cancelled.

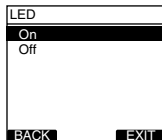

- 3 Press the **PLAY/OK** button to complete the setup screen.

[On Set] or [Off Set] will light up on the display, and it will return to the [Display Menu] screen.

If you press the **|<<<** or **F1(BACK)**, the setting will be cancelled and it will return to the [Display Menu]. Pressing the **F3(EXIT)** button will cancel the contents being set and take you out of the MENU.

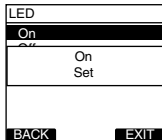

- 4 Press the **F3(EXIT)** or **|<<<** button to complete the setting.

# LCD Contrast Adjustment (Contrast)

Display contrast can be adjusted from level 01 to 12.

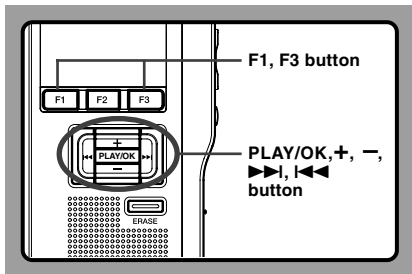

- 1 Select **[Contrast]** at the **[Display Menu]** screen, then press the **PLAY/OK** or **>>>** button.

Refer to P.33 regarding each menu item settings.

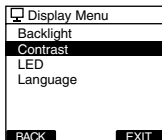

- 2 Press the **+** or **-** button to set the contrast level.

You can adjust the LCD display contrast level from 01 to 12.

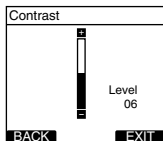

- 3 Press the **PLAY/OK** button to complete the setup screen.

The set contrast level lights up and will return to the [Display Menu] screen.

If you press the **<<<** or **F1(BACK)**, the setting will be cancelled and it will return to the [Display Menu]. Pressing the **F3(EXIT)** button will cancel the contents being set and take you out of the MENU.

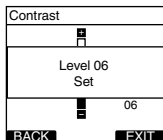

- 4 Press the **F3(EXIT)** or **<<<** button to complete the setting.

# System Sounds (Beep)

When this is set to [On], the recorder beeps to alert you to button operations or warn you of errors.

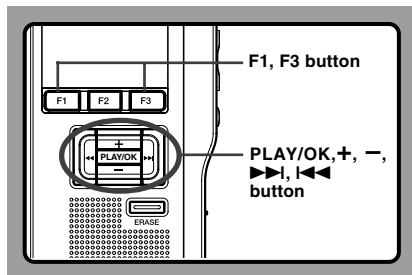

- 1 Select [Beep] at the [Device Menu] screen, then press the **PLAY/OK** or **>>>** button.

Refer to P.33 regarding each menu item settings.

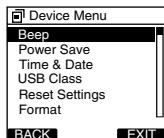

- 2 Press the **+** or **-** button to select [On] or [Off].

**On...**System sounds are enabled.  
**Off...**System sounds are disabled.

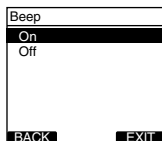

- 3 Press the **PLAY/OK** button to complete the setup screen.

[On Set] or [Off Set] will light up on the display, and it will return to the [Device Menu] screen.

If you press the **<<<** or F1 (BACK) button the setting will be cancelled and it will return to the [Device Menu]. Pressing the F3 (EXIT) button will cancel the contents being set and take you out of the MENU.

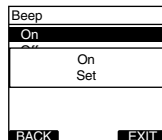

- 4 Press the **F3 (EXIT)** or **<<<** button to complete the setting.

# Formatting the Card (Format)

Cards that have been used in non-Olympus devices, or cards that are not recognized by the recorder, must be formatted before they can be used with the recorder.

To familiarize yourself with the formatting process, read the steps below.

The recorder's menu settings cannot be initialized. The initialization of menu items should be set up through DSS Player or the recorder's [Reset Settings].

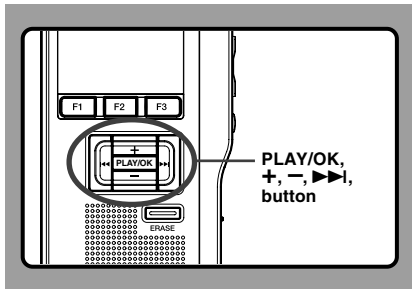

- 1 Select [Device Menu] at the [Format] screen, then press the **PLAY/OK** or **>>>** button.

Refer to P.34 regarding the menu's various setting items.

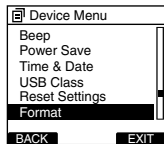

- 2 Press the **+** or **-** button to select [Start] option.

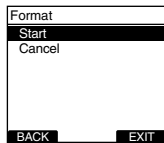

- 3 Press the **PLAY/OK** button to confirm [Start] selection.

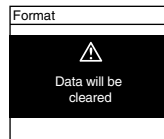

## Formatting the Card (Format)

- 4 Press the **+** or **-** button again to select **[Start]** option.

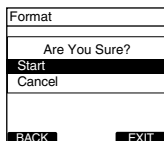

- 5 Press the **PLAY/OK** button again to initiate the formatting process.

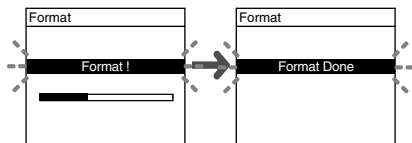

[Format Done] displays when formatting ends.

### Notes

- The time required to format cards differs depending on the capacity of cards. Do not interrupt the formatting process by the following operations. Doing so will damage the data or card.
  - Remove the card.
  - Remove the batteries.
- When the card is formatted, all the stored data, including locked files, are erased.
- If an unformatted card is inserted, the recorder automatically displays the format option in the menu.
- SD cards for which the SD card lock is enabled cannot be initialized.
- Formatting on the recorder will be Quick Format. If you format the card, information of file management is refreshed and the data inside the card is not deleted completely. When handing over and disposing the card, be careful about the data leakage from the card. We recommend the card to be destroyed when you dispose the card.

### Initializing the Recorder's Menu Settings (Reset Settings)

To return the recorder's menu settings to their original status from the time of purchase (initial settings), perform the setting from [Reset Settings] in the [Device Menu], or perform the same operation by using DSS Player.

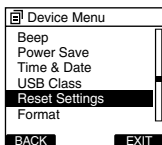

# Check System Information (System info.)

System information about the recorder like its [Model Name], [Version] and [Serial] can be displayed.

In this recorder, you can check the Card Information (⇨ P.9) and File Information (⇨ P.37).

- 2 Press the **PLAY/OK**, **⏪** or **F1 (BACK)** button.
- 3 Press the **F3(EXIT)** or **⏩** button to complete the setting.

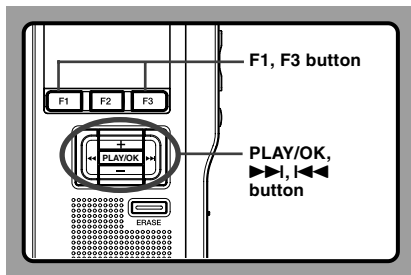

- 1 Select [System info.] at the [Device Menu] screen, then press the **PLAY/OK** or **⏪** button.

[Model Name] [Version] [Serial] will appear.  
Refer to P.34 regarding each menu item settings.

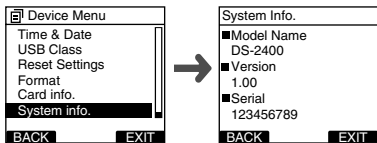

# Changing the USB Class (USB Class)

You can set the USB class of this recorder with a USB connection to [Composite] or [Storage]. Set to [Composite] when using this recorder as a USB speaker or a USB microphone.

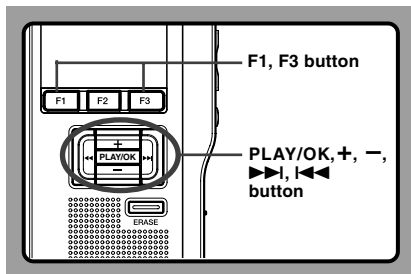

- 1 Select [USB Class] at the [Device Menu] screen, then press the **PLAY/OK** or **>>>** button.

Refer to P.34 regarding each menu item settings.

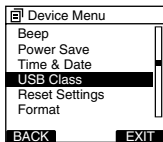

- 2 Press the **+** or **-** button to select [**Composite**] or [**Storage**].

**Composite...**In the 3 classes of Storage, USB audio and human interface, USB connection is possible.

While USB connection in [Composite], the recorder can be used as the USB speaker and the USB microphone.

**Storage...**USB connection is possible in only Storage class.

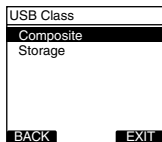

- 3 Press the **PLAY/OK** button to complete the setup screen.

[Composite Set] or [Storage Set] will light up on the display, and it will return to the [Device Menu] screen.

If you press the **<<<** or **F1 (BACK)** button the setting will be cancelled and it will return to the [Device Menu]. Pressing the **F3 (EXIT)** button will cancel the contents being set and take you out of the MENU.

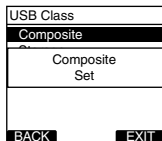

- 4 Press the **F3 (EXIT)** or **<<<** button to complete the setting.

When this recorder is connected to the computer for the first time after being changed to "Remote(Composite)", the driver will be installed automatically to the computer.

# 4 Managing Files on Your PC

## DSS Player Software

The DSS Player is a fully featured software tool that provides a simple to use but sophisticated method of managing your recordings. Some of the features of the DSS Player are:

- Automatic startup of the application by connecting the device.
- Automatic download of Dictation by connecting the device.
- Voice recorder's menu setting.
- Direct recording and editing of existing Dictation through Voice recorder's button.

Make sure that your computer meets the minimum requirements listed below.

### Minimum Requirement

#### Windows

<b>Operating System:</b>	Windows 2000 Professional Service Pack 4 Windows XP Home edition Service Pack 2,3 Windows XP Professional Service Pack 2,3 (32bit/64bit) Windows Vista Home Basic, Service Pack 1 (32bit/64bit) Windows Vista Home Premium, Service Pack 1 (32bit/64bit) Windows Vista Business, Service Pack 1 (32bit/64bit) Windows Vista Enterprise, Service Pack 1 (32bit/64bit) Windows Vista Ultimate, Service Pack 1 (32bit/64bit)
<b>CPU:</b>	Windows 2000/XP: Intel Pentium III 500MHz processor or more Windows Vista: Intel Pentium III 800MHz processor or more
<b>RAM:</b>	Windows 2000/XP: 128MB or more (256MB or more recommended) Windows Vista: 512MB or more (1GB or more recommended)
<b>Hard drive space:</b>	Dictation Module: 70MB or more; (700MB or more with Microsoft .NET Framework Version 2.0 not installed)
<b>Drive:</b>	CD or DVD drive
<b>Display:</b>	800 x 600 pixels or more, 65536 colors more (16.77 million colors or more recommended)
<b>USB port:</b>	With the Dictation Module: One or more free ports available
<b>Audio I/O terminals:</b>	With the Dictation Module: A Microsoft WDM- or MME-compliant and Windows-compatible sound device

### Macintosh

<b>Operating System:</b>	Mac OS X 10.3.9 - 10.5
<b>CPU:</b>	Power PC G3 500MHz or more/Intel Core Solo/Duo 1.5GHz or more
<b>RAM:</b>	256MB or more (512MB or more is recommended)
<b>Hard drive space:</b>	200MB or more
<b>Display:</b>	1024 x 768 pixels or more, 32000 colors or more
<b>USB port:</b>	One or more free ports

---

### Notes

- Macintosh version does not support voice recognition software.
- Currently supported OS are listed on our Web page. For the latest information, please visit the Olympus Web site at <http://www.olympus-global.com/en/global/>.

# Installing DSS Player Software

**Be sure to confirm the following before installation:**

- Exit all running applications.
- Eject the floppy disk if you are using one.
- If you are running Windows 2000/XP/Vista or Mac OS X on the network, you need to log on as an Administrator.

## Windows

For the Windows version, there is an installation method for individuals and one for administrators to install on multiple client PCs. An explanation of the installation method for individuals installing the software on a single PC will be provided here.

### 1 Insert Olympus DSS Player CD into the CD-ROM drive.

The installation program will start automatically. If the installation program does not start automatically, browse your CD-ROM drive and execute "launcher.exe".

### 2 The launcher will startup.

Select the language you would like to install from the upper-left pull-down menu and click [DSS Player Standard Installation].

### 3 The Install Wizard will begin.

Once you have consented to the licensing agreement, enter your name, company name, and license ID number (serial number).

The license ID number is printed on the license ID card included inside the recorder package.

### 4 Proceed with the installation according to the instructions on the screen.

## Macintosh

### 1 Insert Olympus DSS Player CD into the CD-ROM drive.

### 2 Double-click the CD icon.

### 3 Double-click the setup icon.

The Install Wizard will begin. Once you have consented to the licensing agreement, follow the instructions on the screen to complete the installation.

### 4 Proceed with the installation according to the instructions on the screen.

### 5 You will be requested to restart, so conduct a restart by following the instructions.

# Uninstalling DSS Player Software

---

## Windows

- 1 Exit DSS Player program.
- 2 Click the [start] button on the taskbar.
- 3 Select [Add/Remove programs] from the [Control Panel].  
A list of installed applications is displayed.
- 4 Select [Olympus DSS Player Standard], then click the [Change/Remove] button.
- 5 Proceed with the uninstallation according to the instructions on the screen.

## Macintosh

- 1 Exit DSS Player program.
- 2 Double-click “DSS Uninstaller” in [Application] → [DSS Player] folder.  
An uninstaller is displayed.
- 3 Proceed with the uninstallation according to the instructions on the screen.

---

### Note

- The dictation files you made are stored in the [MESSAGE] folder. If you do not need them, delete them. You can confirm the location of the [MESSAGE] folder by clicking on [Options] in the [Tools] menu before uninstalling.

# Using Online Help

---

For information on the DSS Player usage and features, refer to the Online help.

To start Online help:

## Windows

- 1 Click the [start] button, then select [All Programs], [Olympus DSS Player Standard], [Dictation Module Help].
- 2 While DSS Player is running, select the [Help] menu, [Contents].
- 3 While DSS Player is running, press F1 on the keyboard.

## Macintosh

While DSS Player is running, select [DSS Player Help] from the [Help] menu.

---

### Note

- Online help is available after the DSS Player is installed (refer P.51).

# Connecting Recorder to PC

## Connecting to Your PC Using the USB Cable

- 1 Connect the USB cable to the USB port of the PC.
- 2 Confirm that the recorder has stopped and connect a USB cable to the connection port on the recorder.  
If [Remote] is displayed on the recorder, it indicates proper connections.

Once you connect the recorder to your PC, the recorder will be powered through the USB cable.

While PC connection, the SD card is recognized as the respective removable disk drive.

## Disconnecting from Your PC

### Windows

- 1 Click the  on the task bar located at the lower-right corner of the screen. Click [Safely Remove Hardware].  
The drive letter will differ depending on the PC being used.



- 2 Disconnect the USB cable.

### Macintosh

- 1 Move the icon of the recorder's drive displayed on desktop to trash box by drag and drop.
- 2 Disconnect the USB cable.

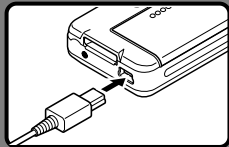
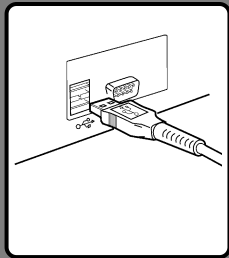

### Notes

- NEVER remove the card or disconnect the USB cable while the record indicator light is flashing. If you do, the data on the card will get destroyed.
- Some PC's may not supply sufficient power and the recorder fails to connect. Refer to your PC User's Manual regarding the USB port on your PC.
- Do not connect the recorder to a PC by using a USB hub. Make sure to connect to a USB port on your PC.
- Make sure to push the cable connector all the way in. Otherwise, the recorder may not operate properly.
- This is an operational environment for saving the files recorded by this recorder to your PC with USB connection.
- Even if operational environment is satisfied, we do not support upgraded OS, the multi-boot environment or self-modified computers.

# Running DSS Player Software

By default, connecting the recorder to your PC, will start the application automatically.

## Windows

### Disabling Automatic Start

- 1 **Right-click the Device Detector in the System Tray in the lower right-hand corner of the screen, then select [Settings startup application].**
- 2 **Click [DSS Player Standard].**  
The check mark on [DSS Player Standard] disappears.

### Manual Start

- 1 **Click the [start] button, then select [All Programs].**  
All program menu will be displayed.
- 2 **Select [Olympus DSS Player Standard], then click [Dictation Module].**

## Macintosh

### Disabling Automatic Start

- 1 **Click the Dock's System Preferences.**
- 2 **Click Device Detector.**
- 3 **Turn the automatic startup setting Off.**

### Manual Start

- 1 **Double click the DSS Player icon for the folder in [Application] → [DSS Player].**  
All program menu will be displayed.
- 2 **Register user information**  
The user's registration screen will be displayed at the time of initial startup. Please input the serial number. Please see the seal attached to the CD-ROM package included with the DSS Player, for the serial number. After the input has ended, click [OK] to complete the registration.

## 5 Other Practical Use Methods

### Using as External Memory of the Computer

---

When the recorder is connected to your PC, it will be recognized on your PC as a removable drive. You can view and access the recorder card from My Computer and download data from the card to your PC using standard windows copy/move and delete commands. You can also upload data from the PC to the card in the recorder in the same way.

#### Example: Copying Data from PC to Card Using Explorer or Finder

---

- 1 Connecting the recorder to your PC.**  
For connection procedure, refer to "Connecting to Your PC Using the USB Cable" (P.54).
- 2 Open Windows Explorer or Finder window.**  
[Removable disk] is displayed.
- 3 Copy the data.**  
The recorder will appear as a removable drive icon.
- 4 Unplug the recorder from a computer.**

---

#### Note

- NEVER remove the card or disconnect the USB cable while the record indicator lamp is flashing. If you do, the data on the card will get destroyed.

## 6 Other Information

### Alarm Message List

<b>Message</b>	<b>Explanation</b>	<b>Action</b>
<b>Battery Low</b>	Battery power is getting low.	Replace with new batteries (☞ P.12).
<b>File Protected</b>	Attempt to delete a locked file.	Unlock the file (☞ P.38).
<b>Index Full</b>	The file is full of index marks (maximum of 32 marks).	Erase index marks that are no longer required (☞ P.39).
<b>Folder Full</b>	The folder is full of files (maximum of 200 files).	Erase unnecessary files (☞ P.29).
	The destination folder already has the maximum number of files (200).	Erase unnecessary files (☞ P.29).
<b>Erase Error</b>	An error occurred while erasing.	Erase once again. When an Erase Error occurs format the card
<b>Card Error</b>	An incompatible card was inserted.	Insert a compatible card (☞ P.16).
<b>Unsupported Card</b>	The card cannot be used with this recorder.	Please remove the card.
<b>Memory Full</b>	The card has no remaining memory.	Erase files that are no longer required or insert another card.
<b>Format Error</b>	There was an error while formatting the card.	Reformat the card (☞ P.45).
<b>System Error</b>	System error detected in the recorder.	This is a malfunction. Contact the place of purchase or Olympus Service Center for repair.
<b>Insert Card</b>	There is no card inserted.	Insert a card (☞ P.16).

# Troubleshooting

Symptom	Probable cause	Action
<b>Nothing appears on the display</b>	The batteries are not loaded properly.	Verify polarity is correct (☞ P.12).
	The batteries are dead.	Replace with new batteries (☞ P.12).
	The recorder is in power off mode.	Turn the recorder ON (☞ P.14).
<b>Won't start</b>	The recorder is in power off mode.	Turn the recorder ON (☞ P.14).
	The batteries are dead.	Replace with new batteries (☞ P.12).
<b>Unable to record</b>	The card does not have enough memory.	Erase unnecessary files or insert another card (☞ P.16, 29).
	The card is unformatted.	Format the card (☞ P.29).
	The maximum number of files has been reached.	Check another folder.
	The SD card is locked.	Unlock the SD card lock (☞ P.8).
<b>No playback tone heard</b>	The earphone is connected.	Unplug the earphones to use the internal speaker.
	The volume level is set to 0.	Adjust the + (Volume) button.
<b>Unable to erase</b>	The file is locked.	Unlock the file (☞ P.38).
	The SD card is locked.	Unlock the SD card lock (☞ P.8).
<b>Noise heard during playback</b>	The recorder was shaken during recording.	—
	The recorder was placed near a cell phone or fluorescent lamp while recording or during playback.	Move the recorder.
<b>Recording level too low</b>	The microphone sensitivity is too low.	Set the microphone sensitivity to Conference mode and try again (☞ P.23).
<b>Unable to set index marks</b>	The maximum number of index marks (32) has been reached.	Erase unnecessary index marks (☞ P.39).
	The file is locked.	Unlock the file (☞ P.38).
	The SD card is locked.	Unlock the SD card lock (☞ P.8).
<b>Cannot find the recorded file</b>	Wrong folder.	Switch to the right folder.
<b>Cannot connect to a PC</b>	Sometimes a connection cannot be made with some PCs running Windows XP or Vista.	You need to change the PC's USB settings. See DSS Player Online help for details (☞ P.53).

# Accessories

---

## **Headset: E62, E102**

Stereo headset for your PC. A helpful tool for PC based transcription.

## **Monaural binaural earphone: E20**

### **Noise-cancellation microphone: ME12 (Dictation microphone)**

Used to get crisp recordings of your own voice by reducing the effects of ambient noise. Recommended to improve the accuracy when using voice-recognition software.

### **External microphone: ME15**

A lavalier omnidirectional microphone that clips to clothing. Used to record your own voice or people near you.

### **Highly sensitive noise-cancellation monaural microphone: ME52W**

This microphone is used to record sound at a distance while minimizing surrounding noise.

### **PC transcription kit: AS-2400**

The AS-2400 transcription kit provides you with a PC-footswitch, a headset and DSS Player Standard Transcription Module for easy transcription of DSS recordings.

### **Connecting cord: KA333**

Use to connect the microphone jack of this unit to a radio or other sound source.

### **Telephone pickup: TP7**

Earphone type microphone can be plugged into your ear while phoning. The voice or conversation over the phone can be clearly recorded.

### **Ni-MH rechargeable battery and charger set: BC400 (Europe only)**

BC400 comes with an Ni-MH rechargeable battery charger (BU-400) and 4 Ni-MH rechargeable batteries (BR401) as a pack. This charger can quick charge Olympus AA or AAA Ni-MH rechargeable batteries.

### **Ni-MH rechargeable battery: BR401**

High-efficiency rechargeable long life batteries.

# Specifications

---

## **Recording format**

DS2 (Digital Speech Standard Pro)

## **Recording media**

SD-card: 512 MB to 16 GB

## **Input level** -70 dBv

## **Sampling frequency**

QP mode: 16 kHz

SP mode: 12 kHz

## **Overall frequency response**

QP mode: 200 to 7,000 Hz

SP mode: 200 to 5,000 Hz

## **Recording time (1 GB Card)**

QP mode: 77 hours 00 minutes

SP mode: 157 hours 50 minutes

## **Alkaline battery life**

### **Recording:**

QP mode: Approx. 24 hours

SP mode: Approx. 30 hours

### **Playback:**

All mode: Approx. 13 hours

## **Speaker**

Built-in  $\varnothing$ 23mm round dynamic speaker

## **MIC/EAR jack**

$\varnothing$ 3.5 mm mini-jack, impedance

MIC 2 k $\Omega$ , EAR 8  $\Omega$  or more

## **Maximum working output (3 V DC)**

250 mW or more (8  $\Omega$  speaker)

## **Input power requirement**

Rated voltage: 5 V

Batteries: Two AAA batteries (LR03 or R03, ZR03) or Two Ni-MH rechargeable batteries

## **External dimensions**

113.5 x 50.0 x 17 mm

(without protrusions)

## **Weight**

105 g (Including alkaline batteries)

\* Specifications and design are subject to change without notice.

\* Battery life is measured by Olympus. It varies greatly according to the type of batteries used and the conditions of use.

# Technical Assistance and Support

---

The following are contact information for technical support for Olympus recorders and software only.

- ◆ Technical Hotline Number in the U.S. and Canada  
1-888-553-4448
- ◆ User Support E-mail address in the U.S. and Canada  
distec@olympus.com
- ◆ Technical Hotline Number in Europe  
Toll free number  
00800 67 10 83 00  
available for Austria, Belgium, Denmark, Finland, France, Germany, Italy, Luxemburg, Netherlands,  
Norway, Portugal, Spain, Sweden, Switzerland, United Kingdom  
Charged numbers for the Rest of Europe  
+49 180 567 1083  
+49 40 23773 4899
- ◆ User Support E-mail address in Europe  
dss.support@olympus-europa.com

## For customers in Europe



“CE” mark indicates that this product complies with the European requirements for safety, health, environment and customer protection.



This symbol [crossed-out wheeled bin Directive 2006/66/EC Annex II] indicates separate collection of waste batteries in the EU countries.

Please do not throw the batteries into the domestic refuse. Please use the return and collection systems available in your country for the disposal of the waste batteries.



This symbol [crossed-out wheeled bin WEEE Annex IV] indicates separate collection of waste electrical and electronic equipment in the EU countries. Please do not throw the equipment into the domestic refuse. Please use the return and collection systems available in your country for the disposal of this product.

Applicable Product: DS-2400



L'indication “CE” signifie que ce produit est conforme aux exigences concernant la sécurité, la santé, l'environnement et la protection du consommateur.



Ce symbole [Poubelle rayée conformément à la directive annexe 2006/66/EC annexe II] indique que la collecte des batteries usagées se fait séparément dans les pays EU.

Veuillez ne pas jeter les batteries dans les ordures ménagères. Veuillez utiliser les systèmes de collection disponibles dans votre pays pour l'enlèvement des batteries usagées.



Le symbole [poubelle sur roue barrée d'une croix WEEE annexe IV] indique une collecte séparée des déchets d'équipements électriques et électroniques dans les pays de L'UE. Veuillez ne pas jeter l'équipement dans les ordures domestiques. A utiliser pour la mise en rebut de ces types d'équipements conformément aux systèmes de traitement et de collecte disponibles dans votre pays.

Produit applicable: DS-2400



La marca “CE” indica que este producto cumple con los requisitos europeos en materia de seguridad, salud, medio ambiente y protección al consumidor.



Este símbolo [Directiva 2006/66/EC Anexo II sobre contenedores] indica que se deben separar las pilas usadas en los países de la UE.

Por favor no tire las pilas en la basura normal. Por favor utilice los sistemas de reciclaje que existan en su país para tirar las pilas.



Este símbolo [un contenedor de basura tachado con una X en el Anexo IV de WEEE] indica que la recogida de basura de equipos eléctricos y electrónicos deberá tratarse por separado en los países de la Unión Europea. No tire este equipo a la basura doméstica. Para el desecho de este tipo de equipos utilice los sistemas de devolución al vendedor y de recogida que se encuentren disponibles.

Producto aplicable: DS-2400

# OLYMPUS®

## OLYMPUS IMAGING CORP.

Shinjuku Monolith, 3-1 Nishi-Shinjuku 2-chome, Shinjuku-ku, Tokyo 163-0914, Japan. Tel. 03-3340-2111  
<http://www.olympus.com>

## OLYMPUS IMAGING AMERICA INC.

3500 Corporate Parkway, P.O.Box 610, Center Valley, PA 18034-0610, U.S.A. Tel. 1-888-553-4448  
<http://www.olympusamerica.com>

## OLYMPUS IMAGING EUROPA GMBH

(Premises/Goods delivery) Wendenstrasse 14-18, 20097 Hamburg, Germany. Tel. 040-237730  
(Letters) Postfach 10 49 08. 20034 Hamburg, Germany.  
<http://www.olympus-europa.com>

## OLYMPUS UK LTD.

Vision House 19 Colonial Way Watford Herts WD24 4JL. Tel.01923-83-1000  
<http://www.olympus.co.uk>

## For customers in North and South America

### *Declaration of Conformity*

Model Number:	DS-2400
Trade Name:	DIGITAL VOICE RECORDER
Responsible Party:	OLYMPUS IMAGING AMERICA INC.
Address:	3500 Corporate Parkway, P.O. Box 610, Center Valley, PA 18034-0610, U.S.A.
Telephone Number:	1-888-553-4448

This device Complies with Part 15 of the FCC Rules. Operation is subject to the following two conditions: (1) This device may not cause harmful interference, and (2) this device must accept any interference received, including interference that may cause undesired operation.

 Tested To Comply  
With FCC Standards  
FOR HOME OR OFFICE USE

## Canadian RFI

This digital apparatus does not exceed the Class B limits for radio noise emissions from digital apparatus as set out in the Radio Interference Regulations of the Canadian Department of Communications.

Cet appareil numérique ne dépasse pas les limites de Catégorie B pour les émissions de bruit radio émanant d'appareils numériques, tel que prévu dans les Règlements sur l'Interférence Radio du Département Canadien des Communications.