

IC Recorder

Operating Instructions

Owner's Record

The model number is located at the rear and the serial number is located inside the battery compartment. Record the serial number in the space provided below. Refer to these numbers whenever you call upon your Sony dealer regarding this product.

Model No. ICD-BM1/BM1PRO Serial No. _____

IC RECORDER

ICD-BM1/BM1PRO

For the customers in the United States

For the customers in the United States INFORMATION

This equipment has been tested and found to comply with the limits for a Class B digital device, pursuant to Part 15 of the FCC Rules. These limits are designed to provide reasonable protection against harmful interference in a residential installation. This equipment generates, uses, and can radiate radio frequency energy and, if not installed and used in accordance with the instructions, may cause harmful interference to radio communications.

However, there is no guarantee that interference will not occur in a particular installation. If this equipment does cause harmful interference to radio or television reception, which can be determined by turning the equipment off and on, the user is encouraged to try to correct the interference by one or more of the following measures:

- Reorient or relocate the receiving antenna.
- Increase the separation between the equipment and receiver.
- Connect the equipment into an outlet on a circuit different from that to which the receiver is connected.
- Consult the dealer or an experienced radio/TV technician for help.

You are cautioned that any changes or modifications not expressly approved in this manual could void your authority to operate this equipment.

For "Memory Stick"

This device complies with Part 15 of the FCC Rules. Operation is subject to the following two conditions: (1) This device may not cause harmful interference, and (2) this device must accept any interference received, including interference that may cause undesired operation.

If you have any questions about this product, you may call:
Sony Customer Information Services Center (800)-222-7669
or write to:

Sony Customer Information Services Center 12451 Gateway Blvd. Fort Myers, FL
33913

Declaration of Conformity

Trade Name: SONY
Model No.: ICD-BM1
Responsible Party: Sony Electronics Inc.
Address: 680 Kinderkamack Road, Oradell, NJ. 07649 USA
Telephone No.: 201-930-6972

This device complies with Part 15 of the FCC Rules. Operation is subject to the following two conditions: (1) This device may not cause harmful interference, and (2) this device must accept any interference received, including interference that may cause undesired operation.

Notice for users

Program © 1999, 2000, 2001, 2002, 2003 Sony Corporation
Documentation ©2003 Sony Corporation

All rights reserved. This manual or the software described herein, in whole or in part, may not be reproduced, translated or reduced to any machine readable form without prior written approval from Sony Corporation.

IN NO EVENT SHALL SONY CORPORATION BE LIABLE FOR ANY INCIDENTAL, CONSEQUENTIAL OR SPECIAL DAMAGES, WHETHER BASED ON TORT, CONTRACT, OR OTHERWISE, ARISING OUT OF OR IN CONNECTION WITH THIS MANUAL, THE SOFTWARE OR OTHER INFORMATION CONTAINED HEREIN OR THE USE THEREOF.

Sony Corporation reserves the right to make any modification to this manual or the information contained herein at any time without notice.

The software described herein may also be governed by the terms of a separate user license agreement.

- This software is for Windows and cannot be used for Macintosh.
- The supplied connecting cable is for the IC recorder ICD-BM1/BM1PRO only. You cannot connect other IC recorders.

Information

IN NO EVENT SHALL SELLER BE LIABLE FOR ANY DIRECT, INCIDENTAL OR CONSEQUENTIAL DAMAGES OF ANY NATURE, OR LOSSES OR EXPENSES RESULTING FROM ANY DEFECTIVE PRODUCT OR THE USE OF ANY PRODUCT.

Trademarks

- “Memory Stick” and  are trademarks of Sony Corporation.
- “LPEC” is the trademark of Sony Corporation.
- IBM and PC/AT are registered trademarks of International Business Machines Corporation.
- Microsoft, Windows and Outlook are trademarks of Microsoft Corporation, registered in the U.S.A. and other countries.
Copyright ©1995 Microsoft Corporation.
All rights reserved.
Portion Copyright ©1995 Microsoft Corporation
- Apple and Macintosh are trademarks of Apple Computer Inc., registered in the U.S.A. and other countries.
- Pentium is a registered trademark of Intel Corporation.
- NaturallySpeaking, Dragon Systems are trademarks owned by ScanSoft, Inc. and are registered in the United States and/or other countries.
- All other trademarks and registered trademarks are trademarks or registered trademarks of their respective holders. Furthermore, “™” and “®” are not mentioned in each case in this manual.

The “Digital Voice Editor” uses software modules as shown below:
Microsoft® DirectX® Media Runtime
©2001 Microsoft Corporation. All rights reserved.

Table of Contents

Getting Started

Step 1: Installing the Batteries	6
Replacing the Batteries	7
Step 2: Setting the Clock	8
Step 3: Inserting a “Memory Stick” into the IC Recorder	10

Basic Operations

Recording Messages	12
Recording as a New Message	15
Adding an Overwrite Recording	15
Using Convenient Functions while Recording	16
Recording with an External Microphone or Other Equipment ...	18
Recording with an External Stereo Microphone	18
Recording from Other Equipment	19
Recording with Other Equipment	19
Playing Back Messages	20
Using the Display Window	24
Selecting the Display Mode	26

Editing Messages

Erasing Messages	28
Erasing Messages one by one	28
Erasing All Messages in a Folder	30
Dividing a Message into Two	31
Adding / Erasing Folders	33
Adding Folders	33
Erasing Folders	34
Moving Messages to a Different Folder	35
Adding Priority Mark(s)— Priority Mark Function	36
Labeling Folders	38

Other Functions

Adjusting the Playback Speed — DPC (Digital Pitch Control)	39
Setting the Overwrite Mode	41
Playing Back a Message at a Desired Time with an Alarm	43
Formatting a “Memory Stick”	47
Changing the Settings — MENU	49
Using the “Digital Voice Editor” Software	52

Additional Information

Precautions	54
Troubleshooting	56
Error messages of the IC Recorder	59
System Limitations	61
Specifications	63
Index to Parts and Controls	64
Index	66

► Getting Started

Step 1: Installing the Batteries

- 1 Slide and lift the battery compartment lid.

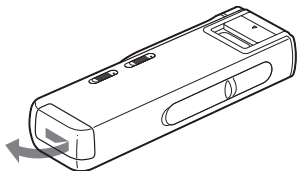

- 2 Insert two LR03 (size AAA) alkaline batteries with correct polarity, and close the lid.

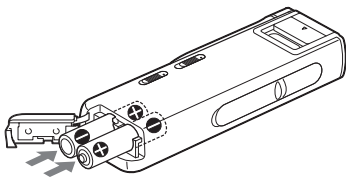

Clock setting display appears when you insert batteries for the first time or after the unit has been without batteries for a certain period of time. Please refer to steps 3 to 6 in “Step 2: Setting the Clock” on pages 8 and 9 to set the date and time.

Using on house current

Connect the AC power adaptor AC-E30HG (not supplied) to the DC IN 3V jack of the unit and to the wall outlet. Do not use any other AC power adaptor.



Polarity of the plug

Replacing the Batteries

The battery indicator on the display window shows the battery condition.

Notes

- Do not use manganese batteries for this unit.
- When you replace the batteries, insert the new ones within 3 minutes after you remove the exhausted ones. Otherwise, the display may show the clock setting or incorrect date and time when you re-insert the batteries. In this case, set the date and time again. The recorded messages and alarm setting, however, will remain.
- Do not charge dry batteries.
- When you are not going to use the unit for a long time, remove the batteries to prevent damage from battery leakage and corrosion.

Battery remain indication



: Replace both of the two batteries with new ones.



: The "LOW BATTERY" is displayed and the unit will stop operation.

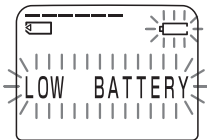

Battery life (Using Sony alkaline batteries LR03 (SG))

(Recording mode:)	ST	SP	LP
In continuous recording:	Approx. 11 hours	Approx. 14 hours	Approx. 16 hours
In continuous playback*:	Approx. 6.5 hours	Approx. 7.5 hours	Approx. 8.5 hours

* When playing back through the internal speaker with the medium volume level

* The battery life may shorten depending on the operation of the unit.

Step 2: Setting the Clock

You need to set the clock to use the alarm function or record the date and time.

Clock setting display appears when you insert battery for the first time, or when you insert battery after the unit has been without battery for a certain period of time. In this case, proceed from step 4.

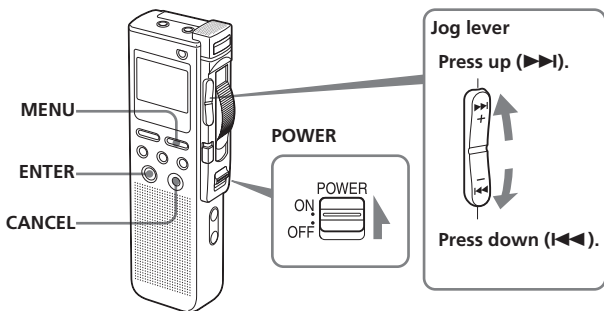

- 1 Slide POWER to ON.**
The IC recorder is turned on.

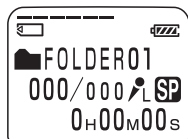

- 2 Press MENU.**
The menu mode will be displayed in the display window.

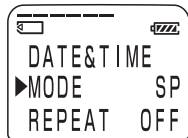

- 3 Press the jog lever up or down (▶▶|/|◀◀) to select "DATE&TIME".**

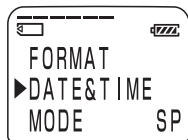

4 Press ENTER.

The date and time setting window is displayed. The year digits will flash.

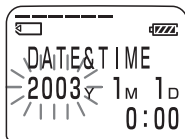

5 Set the date and time.

- ① Press the jog lever up or down (▶▶/◀◀) to select the digits of the year.
- ② Press ENTER.
The month digit will flash.
- ③ Set the month, day, and the time in sequence, then press ENTER.
The menu mode will be displayed again.

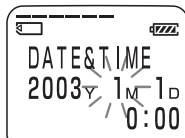

6 Press MENU.

The window will return to the normal display.

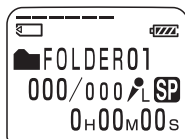

To cancel the operation

Press CANCEL to return to the previous step of the operations.

To display the current time

Press ENTER while the unit is in the stop mode (page 27).

The current time will be displayed for three seconds.

Note

When no "Memory Stick" is inserted or the power is turned off, the current time will not be displayed.

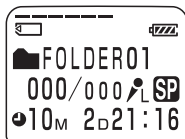

Step 3: Inserting a “Memory Stick” into the IC Recorder

Notes

- Make sure to insert or remove the “Memory Stick” while the unit is turned off.
- Never remove the “Memory Stick” while the unit is accessing the “Memory Stick”. (The OPR indicator flashes in orange.)

1 Slide and open the “Memory Stick” slot cover.

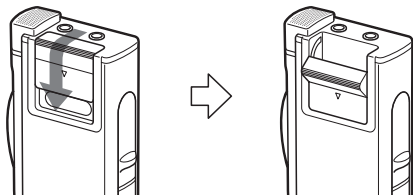

2 Insert a “Memory Stick” into the “Memory Stick” slot with the terminal side facing inside the recorder. Insert it firmly until it clicks into place.

Note

Do not insert a “Memory Stick” in a different direction. It may cause malfunction of the unit.

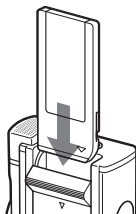

3 Close the “Memory Stick” slot cover.

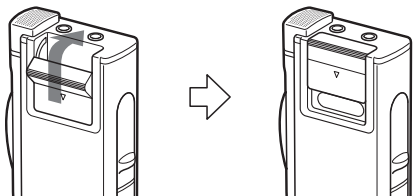

Note on the "ACCESS" message

The unit is accessing data while "MEMORY STICK ACCESS" appears in the display window or the OPR indicator flashes in orange. While accessing, do not remove the "Memory Stick", batteries, or the AC adaptor (not supplied). Doing so may damage the data.

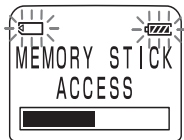
**Notes**

- The unit starts accessing the data after it is turned on.
- If the unit is required to process excessive amount of data, "MEMORY STICK ACCESS" may be displayed for an extended period of time. This is not a malfunction of the unit. Wait until the message disappears.

Removing the "Memory Stick"

Make sure that "MEMORY STICK ACCESS" disappears, and turn off the unit. Then open the "Memory Stick" slot cover and push the "Memory Stick" into the slot, so that the "Memory Stick" pops out. Remove the "Memory Stick" from the slot as shown below.

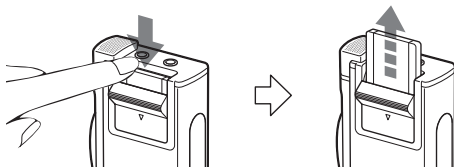
**The types of "Memory Stick" you can use with this IC Recorder**

You can also use the following "Memory Stick" of a 4 MB to 128 MB capacity instead of the supplied "Memory Stick". The maximum recording time varies depending on the capacity of the "Memory Stick".

- "Memory Stick"
- "Memory Stick (with memory select function)" (incorporating two 128MB memory units)
- "MagicGate Memory Stick"
- "Memory Stick Duo" (when inserted into the "Memory Stick Duo" adaptor)

Notes

- The unit does not support the "Memory Stick PRO".
- "MagicGate" is a copyright protection technology that uses an encryption technology. This unit does not support the MagicGate standard, and therefore, recorded data using this unit is not subject to the protection of copyrights by MagicGate.

Recording Messages

You can record messages in each (initially named FOLDER01, FOLDER02, and FOLDER03) folder. The maximum number of recordable messages differs depending on the “Memory Stick” capacity.

You can record messages using the following three functions:

- Add a recording to a previously recorded message (next page)
- Add a recording as a new message (page 15)
- Add an overwrite recording (page 15)

This section explains how to add a recording to a previously recorded message.

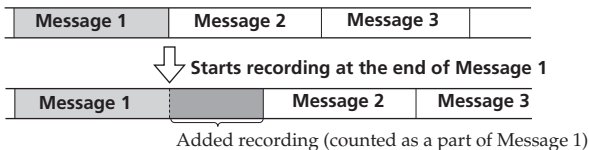

Maximum recording time and number of messages for a “Memory Stick”

The maximum recording time for all the folders and the maximum number of messages are as follows. You can record messages for the maximum recording time in a single folder.

	4MB	8MB	16MB	32MB	64MB	128MB
ST*	10min.	20min.	40min.	1hr 25min.	2hr 50min.	5hr 50min.
SP**	30min.	1hr	2hr 10min.	4hr 20min.	8hr 50min.	17hr 45min.
LP***	1hr 20min.	2hr 50min.	5hr 45min.	11hr 45min.	23hr 35min.	47hr 25min.
Number of Messages	456	950	963	1,016	1,016	1,016

*ST: High quality recording mode (hr: hours /min.: minutes)
(stereo sound with an external stereo microphone not supplied)

**SP: Standard play recording mode (monaural sound)

***LP: Long play recording mode (monaural sound)

Notes

- For switching the recording mode, see page 50.
- Before making a long recording, be sure to check the battery indicator (page 7).
- The maximum recording time and the number of messages you can make vary depending on the conditions of use.
- To avoid replacing batteries during long recordings, use the AC power adaptor (not supplied).

1

Turn on the power.

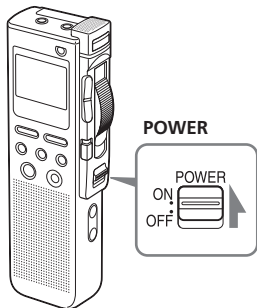

Slide **POWER** to **ON**.

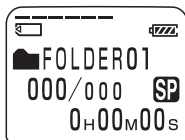

2

Select the folder.

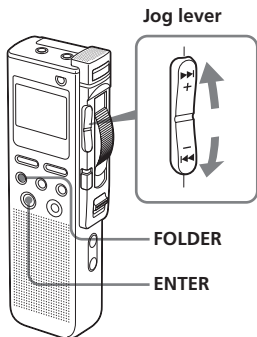

① Press **FOLDER**.

② Press the jog lever up or down (▶▶/◀◀) to display the folder in which you wish to record messages.

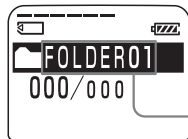

Selected folder

③ Press **ENTER** to select the folder.

To cancel the selection, press **CANCEL**.
To add a new folder, see page 33.

Recording Messages (continued)

3 Start recording.

Built-in microphone

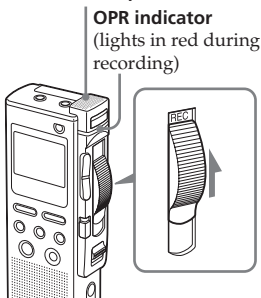

- ① Slide the control key to REC.

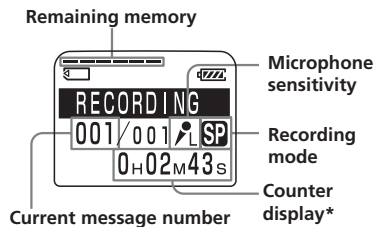

- ② Speak into the built-in microphone.

* The display selected with the DISPLAY button (page 26) appears.

Notes

- While the OPR indicator flashes or when it turns orange, do not remove the "Memory Stick", the batteries or the AC adaptor (not supplied). Doing so may damage the data.
- Noise may be recorded if an object, such as your finger, etc., accidentally rubs or scratches the unit during recording.

4 Stop recording.

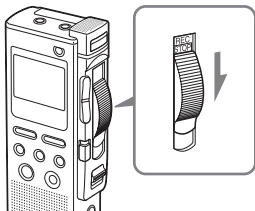

Slide the control key to STOP.

The unit stops at the end of the current recording.

If you do not change the folder after you stop recording, the next time you record you will record from the end of the current recording. The added recording will be counted as part of the current message.

Recording as a New Message

You can add a recording as a new message after the last message in the folder.

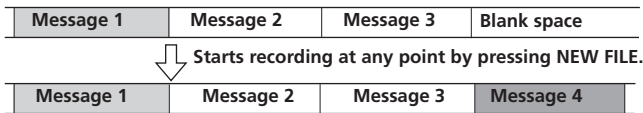

Recorded after the last message as a new message

Before you start recording in step 3 on the previous page, press NEW FILE.

“NEW FILE” will be displayed.

Then slide the control key to REC to start a new recording as the last message in the folder.



Adding an Overwrite Recording

When you start recording at a point in the middle of a recorded message, you add an overwrite recording after the selected point.

Start recording at a point in the middle of a recorded message

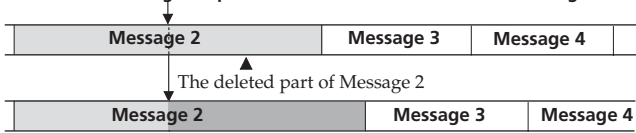

Added overwrite recording in Message 2

Locate the point where you want to start recording (page 21) and then slide the control key to REC.

“ADD REC” will be displayed and you can add an overwrite recording to the current message.

Tips

- You can select the overwrite recording mode using the menu (page 41).
- The overwrite recording will be added in the same recording mode as the original message, regardless of the current recording mode setting.

Note

Playback after the overwrite recording starts from the beginning of the message.

Playback after a stop starts from the point where you stopped playback.

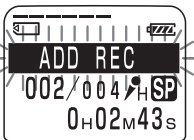

Continued

Recording Messages (continued)

Using Convenient Functions while Recording

Reviewing the recording

Slide the control key to B.SPACE. You can search backwards while listening to fast playback sound. After you slide the control key to PLAY, playback starts from that point. You can add an overwrite recording from that point.

Monitoring the recording

When recording, you can connect an ear receiver supplied or not supplied to the  (headphones) jack and monitor the recording from the connected ear receiver. You can adjust the volume with VOL +/-, but the recording level is fixed.

Note

If you turn up the volume excessively or place the ear receiver near the microphone while monitoring recording, the microphone may pick up the sound from the ear receiver, causing acoustic feedback (howling sound).

Starting recording automatically in response to the sound — Advanced VOR function

Slide the VOR (voice operated recording) switch to ON during stop or recording mode.

Set the control key to REC. Recording starts when the unit detects sound, and “VOR” appears in the display window. The recording pauses when no sound is detected, and “VOR PAUSE” appears.

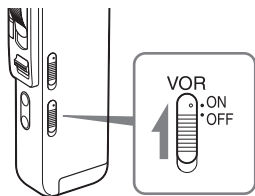

Notes

- Recording will not be started unless the control key is set to REC.
- VOR function is affected by the sound around you. Set the MIC SENS (microphone sensitivity) switch according to the recording conditions. If recording is not satisfactory after you have changed the microphone sensitivity, or for important recording, set the VOR switch to OFF.

Selecting the microphone sensitivity

Slide the MIC SENS (microphone sensitivity) switch during stop or recording mode according to the recording conditions:

- CONF(H) (high): To record a small sound at a conference or in a quiet and/or spacious place.
- DICT(L) (low): To record for dictation.

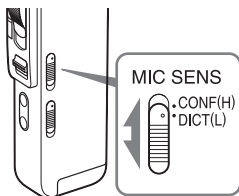

Using the memory remain indication

During recording, the remaining memory indicator decreases one by one. When the remaining recording time reaches 5 minutes, the remaining memory indication flashes.

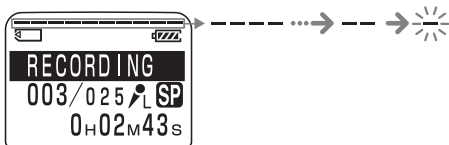

When the remaining time reaches 1 minute, the remaining time indication will flash in the display window regardless of the display mode (page 26).

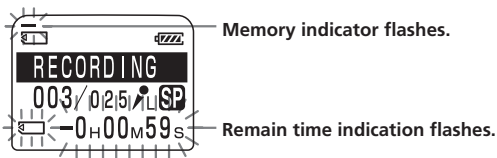

When the memory is full, recording automatically stops and “NO MEMORY SPACE” will be displayed with an alarm sound. Please slide the control key to STOP.

To continue recording, erase some of the messages (page 28) or replace the “Memory Stick”.

Note

When you set the BEEP (page 51) to OFF, an alarm sound (beep) does not sound.

Recording with an External Microphone or Other Equipment

You can record sound of an external microphone or other equipment (tape recorder, MiniDisc player, or etc.) with the IC recorder. Depending on the device you use, connect the IC recorder as follows. For available accessories, consult with your nearest Sony dealer.

Recording with an External Stereo Microphone

Connect an external stereo microphone to the MIC (microphone) jack. You can enjoy the stereo recording by using a stereo microphone.

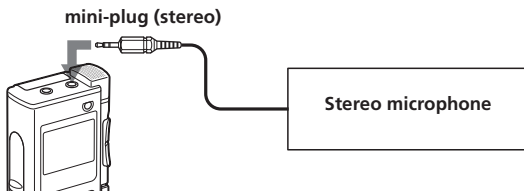

When you connect an external microphone, the built-in microphone is automatically cut off. When a plug in power type microphone is connected, power is automatically supplied to the microphone from the IC recorder.

Recommended types of microphones

You can use the ECM-DS70P Sony electret condenser microphone (not supplied).

Note

Before you start the stereo recording with an external stereo microphone, set MODE to ST in the menu (page 50).

Recording from Other Equipment

To record sound of other equipment with the IC recorder, connect the MIC (microphone) jack of the IC recorder to the earphone jack of other equipment (tape recorder etc.) by using an audio connecting cable.

Notes

- When the audio recording level is large, sound may be recorded interrupted if you use an audio connecting cable without register. Use a registered audio connecting cable.
- When the audio recording level is small, do not use a registered audio connecting cable.

Recording with Other Equipment

To record the sound of the IC recorder with other equipment, connect the  (headphones) jack of the IC recorder to the audio input connector (minijack, stereo) of other equipment.

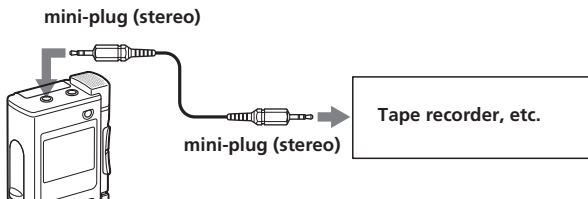

Playing Back Messages

When playing back a previously recorded message, start from Step 1.
When playing back a message you have just finished recording, start from Step 3.

1 Select the folder.

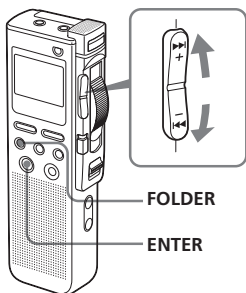

- ① Press FOLDER.
- ② Press the jog lever up or down (▶▶|/|◀◀) to display the folder containing the message you want to play back.



- ③ Press ENTER to select the folder.
To cancel the selection, press CANCEL.

2 Select the message number.

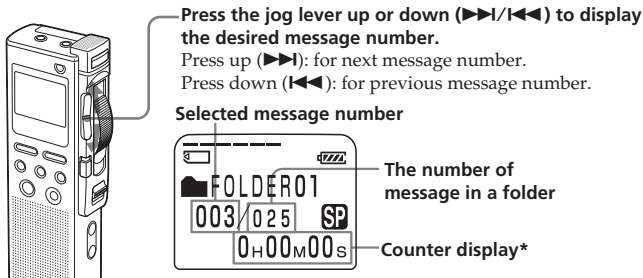

- Press the jog lever up or down (▶▶|/|◀◀) to display the desired message number.
Press up (▶▶|): for next message number.
Press down (|◀◀): for previous message number.

Selected message number

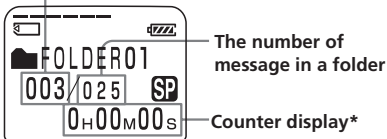

* The display selected with the DISPLAY button (page 26) appears.

3 Start playback.

OPR indicator

(lights in green during playback)

⌚ jack



- ① Slide the control key to PLAY.

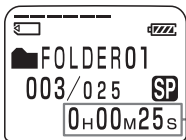

Counter display*

- ② Adjust the volume with VOL +/- .

* The display selected with the DISPLAY button (page 26) appears.

The unit plays back all the messages in a folder continuously. At the end of each message, a beep will sound.

When the unit reaches to the end of the last message in a folder, "MSG END" will flash 3 times with a beep and playback stops. Move the control key to STOP.

🎧 To listen from an ear receiver

Connect the supplied ear receiver to the ⌚ (headphones) jack. The built-in speaker will be automatically disconnected.

🎧 To listen from an external speaker

Connect an active or passive speaker (not supplied) to the ⌚ (headphones) jack.

Note

Playback after the overwrite recording starts from the beginning of the message. Playback after a stop starts from the point where you stopped playback.

4 Stop playback.

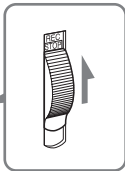

Slide the control key to STOP.

The unit stops at the current position. (When the unit reaches to the end of the last message in step 3, it stops at the end of the last message.)

You can start an overwrite recording from the point (page 15).

Continued

Playing Back Messages (continued)

Other operations

To	Do this
go back to the beginning of the current message*	Press the jog lever down (◀◀) once.**
go back to previous messages*	Press the jog lever down (◀◀) repeatedly. (During stop mode, keep the button pressed to go back the messages continuously.)**
skip to the next message*	Press the jog lever up (▶▶) once.***
skip to the succeeding messages*	Press the jog lever up (▶▶) repeatedly.***

* These operations are for when EASY-S is set to OFF. For operations when EASY-S is set to ON, see page 51.

** If you do these operations at the beginning of the first message in a folder during stop mode, the unit locates the end of the last message.

*** If you do these operations at the end of the last message in a folder during stop mode, the unit locates the beginning of the first message.

Playing back a message rapidly or slowly in natural tone — DPC (Digital Pitch Control)

When you adjust the playback speed with the DPC in the menu (pages 39 and 40), you can play back a message rapidly or slowing by sliding the DPC switch to ON. When you set the playback speed faster or slower of the normal speed, "FAST PLAY" or "SLOW PLAY" appears. You can change the setting during playback.

Searching forward/backward during playback (Cue/Review)

- **To search forward:** Keep pressing the jog lever up (▶▶) during playback and release it at the point you wish to resume playback.
- **To search backward:** Slide the control key to B.SPACE or keep pressing the jog lever down (◀◀) during playback and release it at the point you wish to resume playback.

The unit searches at slow speed (unit of 4 seconds) with playback sound. It is useful to check one word forward or behind. Then, if you keep pressing the jog lever up or down, the unit starts to search at higher speed. Release it at the point you want to resume playback.

🔊 When you play back to the end of the last message

When the unit locates the end of the last message, "MSG. END" flashes 3 times with a beep and the OPR indicator lights in green.

- When "MOVE CONTROL KEY TO STOP POSITION" appears, slide the control key to STOP. The unit will stop at the end of the last message.
- To go back to the beginning of the first message in a folder during stop mode, press the jog lever up (▶▶).
- If you slide the control key to B.SPACE or keep pressing the jog lever down (◀◀), the messages are played back rapidly, and normal playback will start at the point you release the button.
- If the last message is long and you wish to start playback at a later part of the message, keep pressing the jog lever up (▶▶) to go to the end of the message and then press the jog lever down (◀◀) to go back to the desired point.

Quickly locating the point at which you wish to start playback (Easy Search)

When EASY-S is set to ON (page 51) in the menu, you can quickly locate the point you wish to start playback by pressing the jog lever up or down (▶▶/◀◀) repeatedly during playback.

You can go back approximately 3 seconds by pressing the jog lever down (◀◀) once, or advance approximately 10 seconds by pressing the jog lever up (▶▶) once. This function is useful when locating a desired point in a long recording.

Playing back a message repeatedly — Repeat Play

When REPEAT is set to ON in the menu (page 50), you can play back a message repeatedly.

Slide the control key to PLAY. "MSG.REPEAT" will be displayed and the selected message will be played back repeatedly.

To stop playback, slide the control key to STOP.

To resume normal playback, set REPEAT to OFF in the menu.

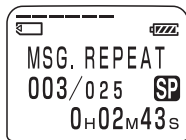

Using the Display Window

Parts in the display window

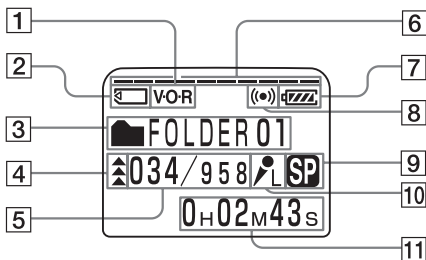

- 1** VOR (voice operated recording) indicator (16)
- 2** "Memory Stick" indicator
- 3** Folder indication (13, 20)
Displays the current folder.
- 4** Priority marks (36)
- 5** Selected message number / Total message number in the folder (14, 20)
- 6** Remaining memory indicator (17)
- 7** Remaining battery indicator (7)
When the AC power adaptor (not supplied) is connected, the indicator does not appear.
- 8** Alarm indicator (45)
Appears when the alarm is set for a message.
- 9** Recording mode indication (50)
 - ST: High quality recording mode (stereo sound with an external stereo microphone not supplied)
 - SP: Standard play recording mode (monaural sound)
 - LP: Long play recording mode (monaural sound)
- 10** Microphone sensitivity indication (17)
Displays the current microphone sensitivity setting with the MIC SENS (microphone sensitivity) switch:
 - H (high): CONF(H) position is selected to record at a meeting or in a quiet/spacious place.
 - L (low): DICT(L) position is selected to record for dictation.
- 11** Counter /Remaining time indication /Recording date and time indication / Message name indication / Current time indication (26, 27)
The display selected with the DISPLAY button appears.

Note

The effect of the back light of the display window may be reduced in a bright location.

■ Display during recording and playback

In an ordinary recording or playback mode, the message number, recording mode and microphone sensitivity of the message being recorded or played back, and playback counter are displayed in the window.

Display examples



A message is being recorded as the 3rd message of all 25 messages in SP mode with L (Low) microphone sensitivity.

In a special playback mode such as DPC play, the mode flashes in the display.

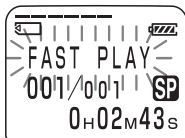

When the DPC switch is set to ON to start playback rapidly.

■ Display during setting the menu

In menu setting mode, the item with the cursor (▶) is selected. The current setting is displayed.

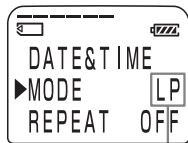

In the mode menu, LP recording mode is being selected.

In alarm or clock setting, you can change the item while it is flashing.

■ Remain indications

When the battery or memory runs out, the remain indications flash in the display.

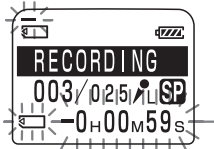

■ Error messages

The error messages will be displayed.

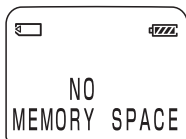

When the remaining memory space runs out.

Selecting the Display Mode

You can select the display mode for stop, recording and playback modes.

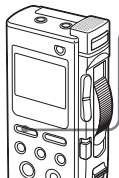

Press **DISPLAY** repeatedly to display the desired display mode.

The display mode changes according to the following order:

ELAPSE TIME (counter)

Elapsed playback/recording time of one message.

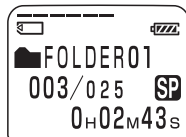

REMAIN TIME (remaining time)

In the playback mode: The remaining time indication of the message.

In the stop and recording mode: The remaining recording time indication.

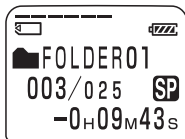

During playback



During recording or stop

REC DATE (recorded date)

The date the current message was recorded. (If the clock has not been set, “---Y--M--D” will be displayed.)

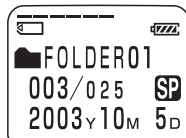

REC TIME (recorded date and time)

The date and time the current message was recorded. (If the clock has not been set, “--M--D--:--” will be displayed. During recording, the current time is displayed.)

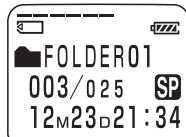

MSG.NAME (message name)

The message name will be displayed in the display window.

If the message has no name, only the message icon (🗨️) will be displayed.



🔊 On Sleep display mode

If the unit is left unused for more than 3 seconds in the stop mode, the display will turn to sleep display mode as shown to the right, regardless of the display mode setting.

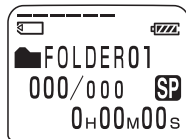

🔊 To display the current time

Press ENTER while the unit is in the stop mode. The current time will be displayed with the clock icon (🕒) for three seconds.

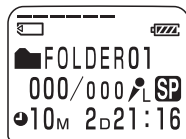

🔊 To turn off the display

Make sure to set the control key to STOP and then slide POWER to OFF.

Every thing on the display will disappear.

If you press a button while the power is off, "POWER IS OFF" flashes. If you slide the control key to any position other than STOP, "MOVE CONTROL KEY TO STOP POSITION" also flashes.

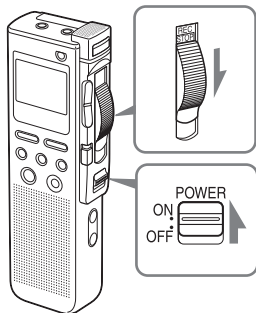

►Editing Messages

Erasing Messages

You can erase the recorded messages one by one or all messages in a folder at a time.

Note

Once a recording has been erased, you cannot retrieve it.

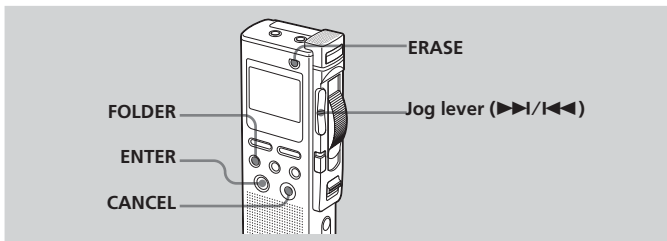

Erasing Messages one by one

Be sure to erase unnecessary messages only.

When a message is erased, the remaining messages will advance and be renumbered so that there will be no space between messages.

Erase Message 3

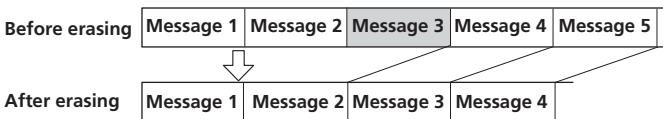

Remaining messages are renumbered.

- 1 Press ERASE while playing back the message you want to erase or press ERASE for more than 1 second during stop mode.**

“ERASE?” will flash while the first and last 5 seconds of the message are played back 10 times.

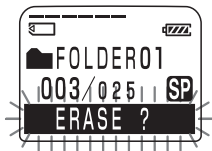

- 2 Press ENTER while the message is being played back and “ERASE” is flashing.**

The message is erased and the remaining messages will be renumbered. (For example, if you erase Message 3, Message 4 will be renumbered as Message 3. When erasing is completed, the unit will stop at the current position.)

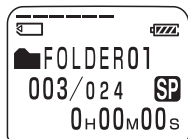

To cancel erasing

Press CANCEL before step 2.

To erase other messages

Repeat steps 1 and 2.

To erase a message partially

First divide the message (see page 31) and then follow the steps on this page to erase the message.

Erasing Messages (Continued)

Erasing All Messages in a Folder

You can erase all recorded messages in a folder.

1 Select the folder containing the messages you want to erase.

For information on selecting a folder, see step 2 of "Recording Messages" on page 13.

2 While pressing FOLDER, press ERASE for more than 1 second.

"ERASE ALL?" will flash for 10 seconds.

If no messages are recorded in a folder

"ERASE FOLDER?" will flash and you can erase the folder itself (see page 34).

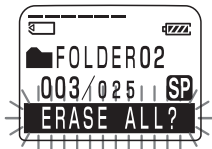

3 While "ERASE ALL?" is flashing, press ENTER.

All the recorded messages contained in the folder are erased. The folder itself will not be deleted. For how to erase a folder, see page 34.

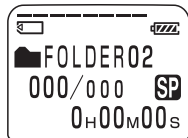

To cancel erasing

Press CANCEL before step 3.

Dividing a Message into Two

You can divide a message into two during playback.

By dividing a message, you can easily find the point you want to play back when you make a long recording such as a meeting.

You can divide a message until the total number of messages in a folder becomes 999 or the total number of messages in a "Memory Stick" becomes 963 with the supplied 16 MB "Memory Stick".

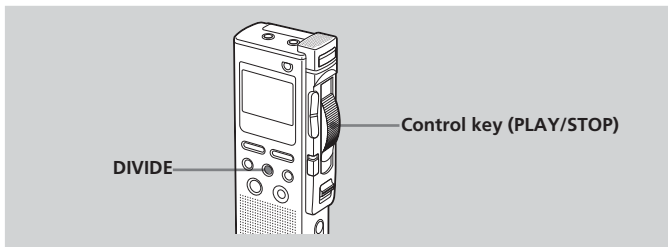

While playing back a message, press DIVIDE at the point you want to divide.

"DIVIDE" flashes for 3 times.

The message is divided into two at the point you pressed the button and the new message number is added to the divided message. The message numbers of the following messages will increase by one.

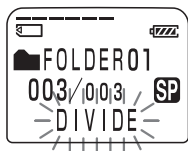

Message 1	Message 2	Message 3	
	↓ ▲ A message is divided.		
Message 1	Message 2	Message 3	Message 4

The message numbers increase.

Continued

Dividing a Message into Two (continued)

To play the divided message

Press the jog lever up or down (▶▶|/|◀◀) to display the message number as the divided messages have message numbers.

Notes

- You need a certain amount of space in the memory to divide a message. For more information, see “System Limitations” on page 61.
- If you divide a message with priority mark(s), priority mark(s) will be added to both parts of the divided message.
- If you divide a message with alarm setting, the alarm setting will remain with the first part of the divided message.
- If you divide a labeled message, the other part of the divided message will have the same message name.

Adding / Erasing Folders

By default setting, there are three folders: "FOLDER01", "FOLDER02", and "FOLDER03". You can add the maximum of 340 folders. You can also delete unnecessary folders.

Note

The maximum number of folders you can add varies depending on the using conditions. "FOLDER FULL" is displayed in the display window when you cannot add any folder because of the system limitations of the IC recorder (page 61).

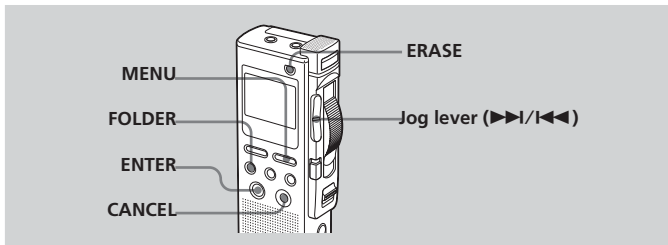

Adding Folders

- 1 Press MENU.**
The menu mode will be displayed.
- 2 Press the jog lever up or down (▶▶|◀◀) to select "NEW FOLDER", and then press ENTER.**
The new folder creation window will be displayed.
- 3 Press the jog lever up or down (▶▶|◀◀) to select "YES", and then press ENTER.**
"NEW FOLDER" will flash and a folder will be added.

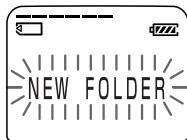
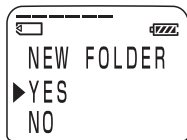

Continued

Adding / Erasing Folders (continued)

4 Press MENU to exit the menu mode.

The window will return to the normal display.

About added folder names

The new folder is labeled automatically with double figures or letter like "FOLDER04". If there is a missing number or letter among the folder names, the new one is labeled using the missing number or letters automatically. You can change the folder name (page 38).

Erasing Folders

You can only erase a folder that has no recorded messages.

1 Select the folder you want to erase.

For information on selecting a folder, see step 2 of "Recording Messages" on page 13.

Note

You cannot erase a folder that has some recorded messages. First, erase all messages in the folder (see page 30) or move them (see the next page).

2 While pressing FOLDER, press ERASE for more than 1 second.

The message number and "ERASE FOLDER" will flash for 10 seconds.

3 While "ERASE FOLDER" is flashing, pressing ENTER.

The folder will be erased.

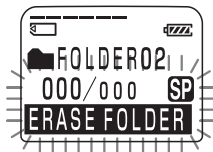

To cancel erasing

Press CANCEL before step 3.

Notes

- You cannot delete the last folder left in a "Memory Stick".
- After deleting a folder, the name of other folders are not changed.
If "FOLDER03" is erased, the name of "FOLDER04" will remain the same.

Moving Messages to a Different Folder

You can move the recorded messages to another folder during playback.

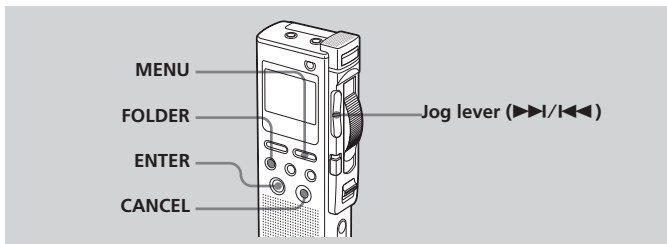

Example: Moving Message 3 in FOLDER02 to FOLDER03

1 Play back the message you want to move.

2 Press **FOLDER**.

The first and last 5 seconds of the message will be played back 10 times, while “MOVE MSG.?” is displayed and flashes and the destination folder with a black background.

3 Press the jog lever up or down (▶▶|/|◀◀) to select the folder you want to move the message into, and then press **ENTER**.

The message is moved in the destination folder. Messages are sorted in order of the recorded date and time or the number of the priority marks in the folder.

The folder with the message you want to move

The destination folder



To cancel moving the message(s)

Press **CANCEL** before step 3.

Note

The move function does not duplicate a message in another folder. When you move a message to another folder, the one in the previous folder will be deleted.

Adding Priority Mark(s)

— Priority Mark Function

Usually the recorded messages are lined up in the order of recording. By adding priority marks (▲) to important messages, you can renumber the messages in the order of their priority. There are four levels, “▲▲▲▲” (the most important), “▲▲▲”, “▲▲”, and no priority mark. You can add priority marks both in the stop mode and in playback mode.

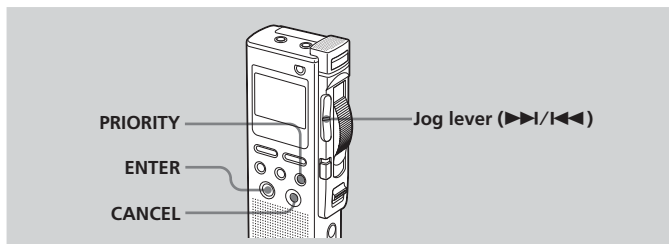

1 Select or play back the message you want to mark.

2 Press **PRIORITY**.

“PRIORITY” will flash on the display window.

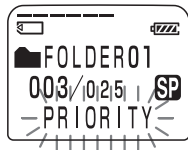

3 Press the jog lever up or down (▶▶/◀◀) to select the number of priority mark(s) (▲) while “PRIORITY” is flashing.

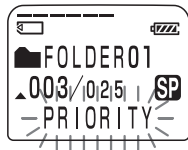

4 Press **ENTER**.

The setting is finished and the messages will be renumbered.

To cancel setting priority mark(s)

Press **CANCEL** before step 3.

Messages with priority mark(s)

Messages are sorted in order of the number of priority mark(s) (▲) in a folder. Messages without a priority mark are moved behind the messages with priority mark(s).

Tip

If there are over 2 messages with the same number of priority marks in a folder, these messages are sorted by the recorded date and time (The oldest one comes first).

e.g. When there are 3 messages in a folder

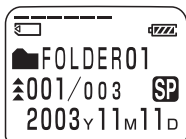

Message 1

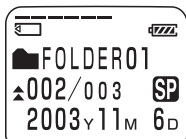

Message 2

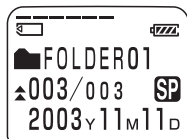

Message 3

Note

You can also add priority mark(s) using the supplied “Digital Voice Editor” software. But messages are not sorted in order of the number of the priority marks unless you sorted by the number of priority marks using the software.

Labeling Folders

Folders are labeled automatically with names modeled on "FOLDER01", but you can use the template names to label folders.

Tip

You can also label folder or messages using the supplied "Digital Voice Editor" software. For more information, see online help.

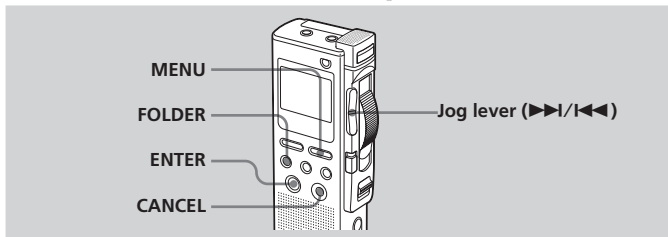

1 Press MENU.

The menu mode will be displayed.

2 Press the jog lever up or down (▶▶I/I◀◀) to select "FOLDER NAME," and then press ENTER.

The folder name input window will be displayed. You can select the folder name from the following templates:

ACTION, APPOINTMNT (appointment), DICTATION, E-MAIL, FOLLOW-UP, LECTURES, LETTERS, MEETINGS, MEMOS, NOTES, PERSONAL, REPORTS, SCHEDULE, TO DO, TRAVEL, OTHERS

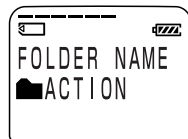

3 Press the jog lever up or down (▶▶I/I◀◀) to select a template name and press ENTER to set the name.

4 Press MENU to exit the menu mode.

The window will return to the normal display.

To cancel labeling

Press CANCEL before step 3.

► Other Functions

Adjusting the Playback Speed — DPC (Digital Pitch Control)

You can adjust the speed of the playback between twice the normal speed (+100%) and half the normal speed (-50%). The message is played back in natural tone thanks to the digital processing function.

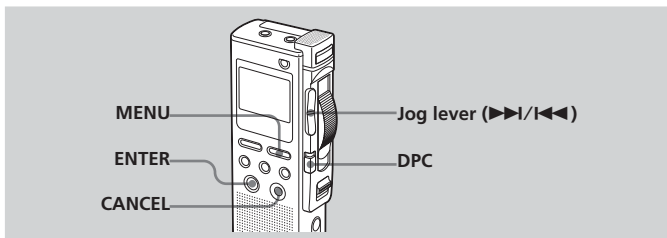

Playing back a message rapidly or slowly

Slide DPC to ON.

“FAST PLAY” or “SLOW PLAY” flashes for 3 seconds and the message is played back at the speed you specified with the menu.

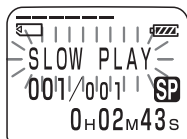
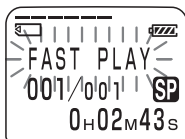

To resume normal playback

Slide the DPC switch to OFF.

Setting the playback speed

You can set the playback speed when the DPC switch is set to ON. The setting for the playback speed holds effective until you change the setting.

1 Press MENU.

The menu mode will be displayed.

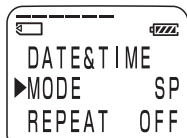

Continued

Adjusting the Playback Speed — DPC (Digital Pitch Control) (continued)

- 2** Press the jog lever up or down (▶▶/◀◀) to select “DPC”.

The current playback speed setting is displayed in percentage with the standard speed as “0%”.

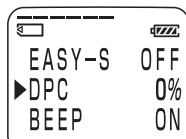

- 3** Press ENTER.

The playback speed setting mode will be displayed.

To return to the previous step, press CANCEL.

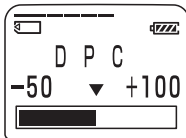

- 4** Press the jog lever up or down (▶▶/◀◀) to set the playback speed.

- **Fast play** (up to +100% in increments of 10%): Press up (▶▶).
- **Slow play** (down to -50% in decrements of 5%): Press down (◀◀).

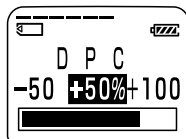

- 5** Press ENTER.

The specified playback speed is confirmed.

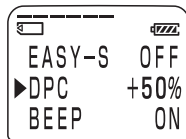

- 6** Press MENU to exit the menu mode.

The normal display appears.



Setting the Overwrite Mode

You can select the overwrite mode when you add an overwrite recording to a previously recorded message.

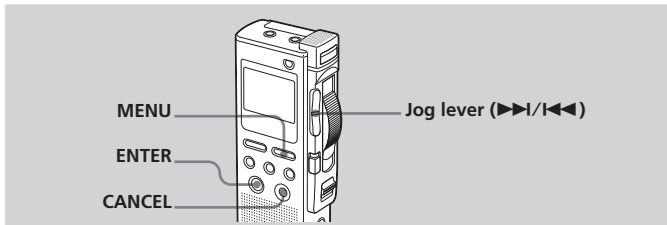

1 Press **MENU**.
The menu mode will be displayed.

2 Press the jog lever up or down (▶▶/◀◀) to select "OVER WT" (overwrite), then press **ENTER**.
The overwrite mode selection window is displayed.

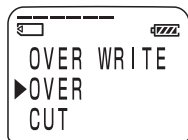

- **OVER:** The portion left after the overwrite recording will remain in the message.

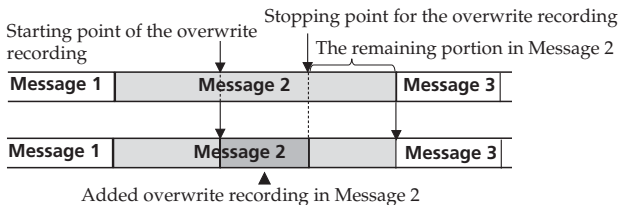

Continued

Setting the Overwrite Mode (continued)

- CUT**: The portion left after the overwrite recording will be deleted.

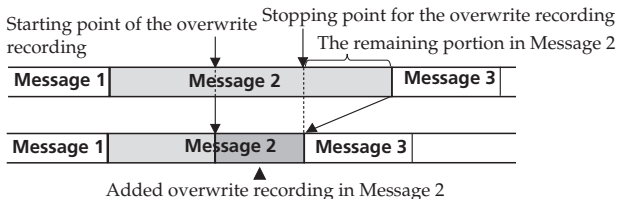

- 3** Press the jog lever up or down (▶▶/◀◀) to select "OVER" or "CUT", then press ENTER.

- 4** Press MENU to exit the menu mode.
The normal display appears.
When you add an overwrite recording (page 15), the recording will be added in the selected overwrite mode.

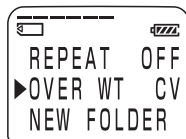

To cancel setting

Press CANCEL. The window returns to that of the previous step.

Playing Back a Message at a Desired Time with an Alarm

You can sound an alarm and start playback of a selected message at a desired time. You can have the message played back at a specified date, once every week, or the same time everyday.

You can also sound the alarm without playing back a message.

Note

When the clock is not set or no messages are recorded, you cannot set the alarm.

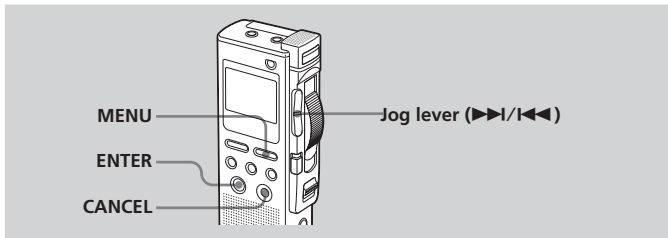

1 Select the message you want to play back.

For more information about selecting the desired message, see step 1 and 2 of “Playing Back Messages” on page 20.



2 Enter the alarm setting mode.

- ① Press MENU.
The menu mode will be displayed in the display window.
- ② Press the jog lever up or down (▶▶|/◀◀) to select “ALARM OFF”.
If the alarm has been already set to “ON”, “ALARM ON” will be displayed.
- ③ Press ENTER.
The alarm setting mode will be displayed in the display window.

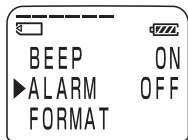

Continued

Playing Back a Message at a Desired Time with an Alarm (continued)

- ④ Press the jog lever up or down (▶▶|/|◀◀) to select "ON".
If "ON" has already been selected, follow the next steps.



- ⑤ Press ENTER.
"DATE" will be displayed in the display window.



3 Set the alarm date and time.

To play back on a desired date

- ① Press ENTER while "DATE" is displayed.
The year digits will flash.
- ② Press the jog lever up or down (▶▶|/|◀◀) to select the year digits and press ENTER.
The month digits will flash.
- ③ Set the month, day, and the time in sequence, then press ENTER.

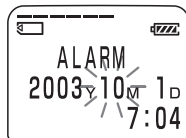

To play back once a week

Press the jog lever up or down (▶▶|/|◀◀) to select the day of the week ("SUN" for Sunday to "SAT" for Saturday). Then press ENTER.

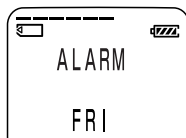

To play back at the same time every day

Press the jog lever up or down (▶▶|/|◀◀) to select "DAILY". Then press ENTER.



4 Select the alarm time.

- ① Press the jog lever up or down (▶▶/◀◀) to select the hour digits, and press ENTER.
The minute digit will flash.
- ② Press the jog lever up or down (▶▶/◀◀) to select the minute digits, and press ENTER.

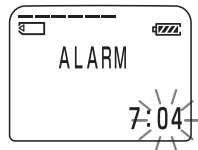
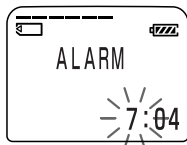

5 Press the jog lever up or down (▶▶/◀◀) to select the alarm sound either from "BEEP & PLAY" (for starting playback after the alarm) or "BEEP ONLY" (for only the alarm).



6 Press ENTER.

The setting is finished.

7 Press MENU to exit the menu mode.

The display returns to the normal display.
“(●)” is displayed when the message having an alarm setting is selected.

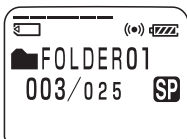

To go back to the previous step

In steps 2 through 5, press CANCEL to go back to the previous step.

When the set date and time comes

At the set time, the alarm will sound for about 10 seconds and the selected message will be played back (If you have selected "BEEP ONLY" in step 5, only the alarm will sound).

During alarm playback, "ALARM" will flash in the display window.

☞ To listen to the same message again

Slide the control key to PLAY. The same message will be played back from the beginning.

☞ To cancel the alarm setting before the playback starts

Press CANCEL while the alarm sound is heard.

Playing Back a Message at a Desired Time with an Alarm (continued)

To cancel the alarm setting

In step 2 on page 43, select "OFF" and then press ENTER.

To check the alarm setting

Follow steps 1 through 2 on page 43 to display the current alarm date and time. Then follow steps 3 to 7 on pages 44 and 45 to change the alarm date and time.



Notes

- If the alarm time comes while another message is being played back with an alarm, the playback stops and the new message will be played back.
- If the alarm time comes during recording, the alarm will sound after the recording is finished. "Ⓜ" will flash when the alarm time comes.
- If more than one alarm time comes during recording, only the first message will be played back.
- When the alarm time comes when the unit is in the menu mode, alarm will sound and the menu mode will be cancelled.
- If you divide a message you set the alarm for, alarm setting remains on only the first part of the divided message.
- Alarm setting will not be cancelled when the alarm playback finishes.

Formatting a "Memory Stick"

You can format a "Memory Stick" using the Memory Stick IC Recorder. Formatting will delete all data recorded in the "Memory Stick" including images and other data. Before formatting, check the data in the "Memory Stick".

Because a commercially available "Memory Stick" has already been formatted at the factory, you do not need to format a "Memory Stick" before the first use.

The supplied "Memory Stick" has also already been formatted.

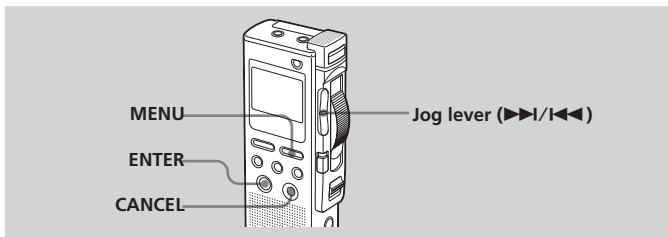

- 1 Press MENU.**
The menu mode will be displayed.
- 2 Press the jog lever up or down (▶▶|/|◀◀) to select "FORMAT".**
- 3 Press ENTER.**
The formatting window will be displayed.
- 4 Press the jog lever up or down (▶▶|/|◀◀) to select "YES".**

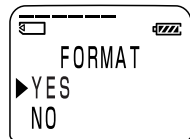

Formatting a "Memory Stick" (continued)

5 Press ENTER.

"OK?" will be displayed in the display window.

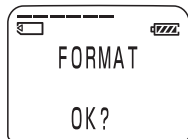

6 Press ENTER again.

Formatting starts.

"FORMATTING" will be displayed on the display.

After formatting, the display in step 2 will appear in the display window.



7 Press MENU to exit the menu mode.

The window will return to the normal display.

After formatting, three folders are automatically made in the "Memory Stick" (This is the same after inserting a "Memory Stick" for the first time.)

To cancel formatting

Select "NO" in the step 4 or press CANCEL while "OK ?" is displayed in step 5.

Note

You cannot format when the write-protect switch on the "Memory Stick" is set to "LOCK".

Changing the Settings — MENU

You can use the menu to change the IC recorder settings. You cannot use the menu during recording. During playback or during stop mode without a “Memory Stick” inserted, the menu items to be displayed are limited. Follow the procedures below to display the menu and change the settings:

- ① Press MENU.
The menu mode will be displayed.
- ② Press the jog lever up or down (▶▶/◀◀) to select the menu item for which you want to change setting.
- ③ Press ENTER.
The setting mode of the selected menu item will be displayed.
- ④ Press the jog lever up or down (▶▶/◀◀) to select the setting that you want to set, and then press ENTER.
The setting will be changed.
- ⑤ Press MENU to exit the menu mode.
The window will return to the normal display.

To go back to the previous step

Press CANCEL.

Note

If you do not press any keys for one minute, the menu mode is automatically cancelled and the window will return to the normal display.

Changing the Settings — MENU (continued)

Menu items	Settings (*: Initial setting)	NO-MS/Stop/Play**
DATE&TIME	Displays the window to set the clock (03Y1M1D*). See page 8.	OK/OK/-
MODE	Displays the window to set the recording mode: ST: You can record with stereo sound with an external stereo microphone (not supplied). (When recording with the built-in microphone, you can record with high quality monaural sound). SP*: You can record with better sound (monaural sound). LP: You can record for longer time (monaural sound).	OK/OK/-
REPEAT	Displays the window to set the repeat playback mode. ON: You can play back a message repeatedly until you stop playback. OFF*: When a message is played back, the next message will be played back (normal playback mode).	OK/OK/OK
OVER WT	Displays the window to set the overwrite recording mode (OVER*/CUT). See page 41.	-/OK/-

**Displays whether you can change the setting in each operation mode:

NO-MS: stop mode with no "Memory Stick" inserted.

Stop: stop mode with the "Memory Stick" inserted.

Play: playback mode

"OK" shows the setting can be changed and "-" shows the setting cannot be changed.

Menu items	Settings (*: Initial setting)	NO-MS/Stop/Play**
NEW FOLDER	Displays the window to add a new folder (YES/NO*). See page 33.	-/OK/-
FOLDER NAME	Displays the window to change a folder name. See page 38.	-/OK/-
EASY-S	<p>Displays the window to set the easy search function.</p> <p>ON: You can go back for approx. 3 seconds by pressing the jog lever down (◀◀), or advance for approx. 10 seconds by pressing the jog lever up (▶▶).</p> <p>OFF*: You can go back or forward the messages by pressing the jog lever down or up (◀◀/▶▶).</p>	OK/OK/OK
DPC	Displays the window to set the playback speed (ON/OFF*). See page 39.	OK/OK/OK
BEEP	<p>ON*: A beep will sound to indicate that operation has been accepted.</p> <p>OFF: No beep sound will be heard except for the alarm.</p>	OK/OK/-
ALARM	Displays the window to set the alarm (ON/OFF*). See page 43.	-/OK/-
FORMAT	Displays the window to format a "Memory Stick" (YES/NO*). See page 47.	-/OK/-

Using the "Digital Voice Editor" Software

By connecting the IC recorder to your computer with the supplied USB cable, you can use the "Digital Voice Editor" software to do the following:

- Saving new IC recorder messages automatically on your computer's hard disk (AutoSave function)
- Saving the selected IC recorder messages on your computer's hard disk.
- Transferring the PC messages back to the IC recorder.
- Playing or editing the messages on your computer.
- Sending a voice e-mail message using MAPI e-mail software.
- Transcribing your IC recorder message using Dragon NaturallySpeaking® speech-recognition software (not supplied).

For the details, see the supplied "Digital Voice Editor 2" software operating instructions.

Connection

When you connect your IC recorder to the computer, "PC CONNECT" is displayed on the display window. The IC recorder enters into PC operation mode. Proceed with the operations with your computer.

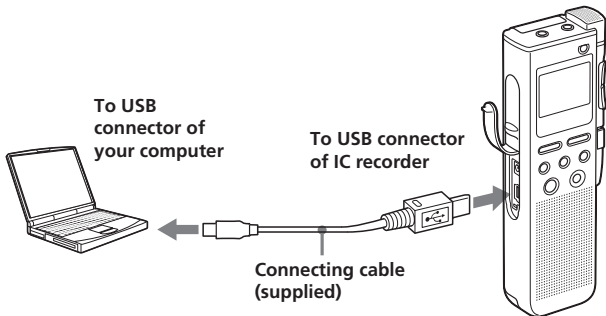

Notes when you connect your IC recorder to the computer

- Do not connect the AC power adaptor (not supplied) to the unit.
- Do not connect the ear receiver or headphones to the unit.
- Make sure to keep the batteries installed in the unit.

System requirements

Your computer and system software must meet the following minimum requirements.

- IBM PC/AT or compatible
 - CPU: 266MHz Pentium® II processor or higher
 - RAM: 64MB or more
 - Hard disk space: 70MB or more depending on the size and number of sound files you store
 - CD-ROM drive
 - USB port
 - Sound board: Sound Blaster 16 compatible
 - Display: High color (16 bits) or more and 800 x 480 dots or more
- OS: Microsoft® Windows® XP Home Edition/XP Professional/2000 Professional/Millennium Edition/98/98 Second Edition standard installation (You cannot use this software with Windows® 95 or Windows® NT.)

Notes

- You cannot use the software with a Macintosh machine.
- A handmade computer, a computer whose operating system is installed or upgraded by the user, or a computer with multi-boot operating environment are not supported.

Precautions

On power

- Operate the unit only on 3 V DC. Use two LR 03 (size AAA) alkaline batteries.

On safety

- Do not operate the unit while driving, cycling or operating any motorized vehicle.

On handling

- Do not leave the unit in a location near heat sources, or in a place subject to direct sunlight, excessive dust or mechanical shock.
- Should any solid object or liquid fall into the unit, remove the batteries and have the unit checked by qualified personnel before operating it any further.

On noise

- Noise may be heard when the unit is placed near an AC power source, a fluorescent lamp or a mobile phone during recording or playback.
- Noise may be recorded when an object, such as your finger, etc., rubs or scratches the unit during recording.

On maintenance

- To clean the exterior, use a soft cloth slightly moistened in water. Do not use alcohol, benzine or thinner.

If you have any questions or problems concerning your unit, please consult your nearest Sony dealer.

Backup recommendations

To avoid potential risk of data loss caused by accidental operation or malfunction of the IC recorder, we recommend that you save a backup copy of your recorded messages to a computer, etc.

On using a “Memory Stick”

- Do not touch or allow metallic objects to come into contact with the metal parts of the connecting section.
- Stick the label supplied for the “Memory Stick” only on the labeling position. Do not use any other labels.
- Do not bend, drop or apply strong shock to the “Memory Stick”.
- Do not disassemble or modify the “Memory Stick”.
- Do not let the “Memory Stick” get wet.
- Do not use or keep the “Memory Stick” in locations that are:
 - Extremely hot such as in a car parked in the sun
 - Under direct sunlight
 - Very humid or subject to corrosive gases
- When you carry or store a “Memory Stick”, put it in its case.

About write-protect of a “Memory Stick”

Write-protect switch

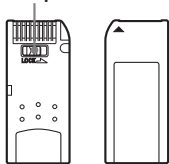

You cannot record or erase data when the write-protect switch on the “Memory Stick” is set to “LOCK”.

Troubleshooting

Before taking the unit for repair, check the following sections. Should any problem persist after you have made these checks, consult your nearest Sony dealer.

Symptom	Remedy
The unit does not operate.	<ul style="list-style-type: none">•The batteries have been inserted with incorrect polarity (page 6).•The batteries are weak.
No sound comes from the speaker.	<ul style="list-style-type: none">•The ear receiver or headphones are plugged in.•The volume is turned down completely.
Sound comes from the speaker even when the ear receiver is plugged in.	<ul style="list-style-type: none">•If you plug in the ear receiver not securely during playback, the sound may come from the speaker. Unplug the ear receiver and then insert it securely.
You cannot start recording.	<ul style="list-style-type: none">•The "Memory Stick" is full. Erase some of the messages (page 28).•There is no "Memory Stick" inserted.•The write-protect switch on the inserted "Memory Stick" is set to "LOCK" (page 55).•999 messages have been recorded in the selected file. Select another file or erase some of the messages (page 28).
You cannot erase a message.	<ul style="list-style-type: none">•The write-protect switch on the inserted "Memory Stick" is set to "LOCK" (page 55).•The message or the folder which contains the message is set to "Read-only" in the computer. Open the data in a "Memory Stick" using Windows Explorer and remove the check for "Read-only" under "Properties".

Symptom	Remedy
You cannot overwrite.	<ul style="list-style-type: none"> •The remaining memory is too short. The overwritten part will be deleted after the overwriting part finishes recording. Therefore, you can only overwrite within the remaining recording time.
Recording is interrupted.	<ul style="list-style-type: none"> •The advanced VOR function (page 16) is activated. Set the VOR switch to OFF.
Noise is heard.	<ul style="list-style-type: none"> •An object, such as your finger, etc., accidentally rubbed or scratched the unit during recording so that noise was recorded. •The unit was placed near an AC power source, a fluorescent lamp or a mobile phone during recording or playback. •Plug of the connected microphone was dirty when recording. Clean the plug. •Ear receiver/headphones plug is dirty. Clean the plug.
Recording level is low.	<ul style="list-style-type: none"> •The MIC SENS switch is set to "DICT(L)". Set it to "CONF(H)" (page 17).
Recording level is unstable (when recording music, etc.)	<ul style="list-style-type: none"> •This unit is designed to automatically adjust the recording level when recording meetings, etc., and is not suitable for music recording.
Recording is interrupted (when recording from an external device).	<ul style="list-style-type: none"> •If you use an audio connecting cable without register to connect the sound source to the IC recorder, sound may be recorded interrupted. Make sure to use a registered audio connecting cable.
Playback speed is too fast or too slow.	<ul style="list-style-type: none"> •The playback speed is adjusted in DPC. Slide the DPC switch to OFF or display the menu and adjust the speed in DPC again (page 39).

Troubleshooting (continued)

Symptom	Remedy
"--:--" is displayed.	• You have not set the clock (page 8).
"--Y--M--D" or "--:--" is displayed on the REC DATE display.	• The date of recording will not be displayed if you recorded the message when the clock was not set.
There are fewer menu items in the menu mode.	• There are some menu items which are not displayed because a "Memory Stick" is not inserted (page 50).
A character in a folder or message name is displayed as "□".	• The unit cannot support and display some characters which are entered using the supplied "Digital Voice Editor" software.
Messages are not sorted in order of the number of priority marks in a folder.	• Unless you sort messages using the supplied "Digital Voice Editor" software, messages are sorted in the unit the same as the setting in the computer. Sort again in the order of the number of priority marks in the computer using the supplied "Digital Voice Editor" software.
The remaining time displayed in the display window is shorter than that displayed in the supplied "Digital Voice Editor" software.	• The unit requires a certain amount of memory for system operation. That amount is subtracted from the remaining time, which is the reason for the difference.
The unit does not operate correctly.	• Take out the batteries and insert them again (page 6).

Please note that recorded messages may be erased during service or repair work.

Error messages of the IC Recorder

Error message	Cause/Remedy
"ACCESS ERROR"	• Remove and insert the "Memory Stick" again. If this is displayed again, the inserted "Memory Stick" needs to be formatted (page 47). Back up the data in the computer after checking the contents.
"ALREADY SET"	• You set the alarm to play back a message at a date and time previously set on another message. Change the alarm setting.
"BACK DATE"	• You set the alarm when the time is already past. Check it and set the appropriate date and time.
"CLOSE MS SLOT COVER"	• The Memory Stick slot cover is open. During operation, make sure to close it.
"FILE PROTECTED"	• Messages have been set to "Read-only" in the computer. You cannot edit or erase messages and folders including these "Read-only" messages. Remove the check for "Read-only" under "Properties" of files that are opened by Windows Explorer.
"FOLDER ERASE PROHIBITED"	• You cannot delete a folder when there is only one folder in the "Memory Stick".
"FOLDER FULL"	• You cannot add a folder when there are the maximum number of folders. Erase some folders before adding.
"FOLDER PROTECTED"	• Folders have been set to "Read-only" in the computer. You cannot edit, erase, add messages, or move messages in these "Read-only" folders. Remove the check for "Read-only" under "Properties" of folders that are opened by Windows Explorer.
"FORMAT ERROR"	• You cannot use the "Memory Stick" formatted with other devices. Use the FORMAT in the menu to format the "Memory Stick".

Troubleshooting (continued)

Error message	Cause/Remedy
"LOW BATTERY"	• Batteries are weak. Replace batteries with new ones.
"LOW DC-IN" / "HIGH DC-IN"	• An AC power adaptor that is not compatible with the IC recorder is connected. Make sure to use the AC power adaptor for the IC recorder.
"MEMORY STICK ERROR"	• Insert the "Memory Stick" again. After inserting, if this message is displayed again, the inserted "Memory Stick" may be out of order.
MEMORY STICK LOCKED"	• The write-protect switch on the inserted "Memory Stick" is set to "LOCK" (page 55). You cannot record, edit or format in this condition. Release the switch and insert the "Memory Stick" again.
"MOVE CONTROL KEY TO STOP POSITION"	• The control key is at a position other than STOP although the unit stops. To proceed with the operations, make sure to slide the control key to STOP.
"FULL"	• Because there are already 999 messages in a folder or the remaining memory of the "Memory Stick" is short, you cannot record a message. Erase some messages before recording.
"NO MEMORY SPACE"	• The remaining memory of the "Memory Stick" is too small. Erase some messages before recording (page 28).
"NO MEMORY STICK"	• Insert the "Memory Stick" again if already inserted.
"NO MESSAGE"	• The selected folder does not have any messages. You cannot set the alarm, etc. because of this.
"PLEASE SET DATE&TIME"	• If you do not set date and time, you cannot make alarm setting. To set date and time, see page 8.
"UNKNOWN DATA"	• The unit cannot play or erase the selected message because the file type is different.

For the error messages of the "Digital Voice Editor", please refer to the online Help files.

System Limitations

There are some system limitations of the unit. Troubles as mentioned below are not malfunctions of the unit.

Symptom	Cause/Remedy
You cannot record messages up to the maximum recording time.	<ul style="list-style-type: none">• If you record messages in a mixture of ST, SP and LP modes, the recordable time varies from the maximum ST mode recording time to the maximum LP mode recording time.• There may be other formatted data (for example, images) in the inserted "Memory Stick".• Due to the minimum recording unit, if the length of each message cannot be divided by the minimum recording unit, the remaining recording time may decrease by more than the total length of the messages.• The maximum recording time varies depending on the number of folders or messages.
You cannot divide a message.	<ul style="list-style-type: none">• You cannot divide a message in a folder which has 999 messages.• Remaining memory of the inserted "Memory Stick" is too short. If the amount of remaining memory is shorter than that of the minimum recording unit, you cannot divide a message.
You cannot add a folder.	<ul style="list-style-type: none">• Remaining memory of the inserted "Memory Stick" is too short. If the amount of remaining memory is shorter than that of the minimum recording unit, you cannot add a folder.

Continued

Troubleshooting (continued)

About the minimum recording unit

For recording a message, dividing a message, or creating a folder, the time of the minimum recording unit is needed. Although the actual recording time of a message may be less than that of the minimum recording unit, the time of the message is counted as a minimum recording unit.

If the remaining recording time of the inserted "Memory Stick" is less than that of the minimum recording unit, you cannot divide a message or create a folder in the "Memory Stick".

The minimum recording unit

Capacity of the "Memory Stick"	ST mode	SP mode	LP mode
4 MB	2 seconds	4 seconds	11 seconds
8 MB	2 seconds	4 seconds	11 seconds
16 MB	2 seconds	8 seconds	22 seconds
32 MB	2 seconds	8 seconds	22 seconds
64 MB	2 seconds	8 seconds	22 seconds
128 MB	2 seconds	8 seconds	22 seconds

About the maximum recording time and the maximum number of messages or folders

A "Memory Stick" saves not only recorded messages but also the information about division and the number of folders. Therefore, as the number of messages or folders increases, the amount of memory in the "Memory Stick" decreases.

The maximum recording time and the number of messages or folders varies depending on this.

However, only in the case that you recorded up to the maximum recording time, you can divide a message into three parts and delete the unnecessary part in the message.

Specifications

Recording media	“Memory Stick”, Monaural recording
Recording time	See page 12.
Frequency range	ST: 60 Hz - 13,500 Hz SP: 60 Hz - 7,000 Hz LP: 80 Hz - 3,500 Hz
Speaker	approx. 28 mm (²⁹ / ₃₂ in.) dia.
Power output	350 mW
Input/Output	<ul style="list-style-type: none">• Earphone jack (minijack) for 8 - 300 ohms ear receiver/headphones• Microphone jack (minijack, stereo) Plug in power Minimum input level: 0.7 mV 3 kilohms or lower impedance microphone• USB connector• DC IN 3V jack
Playback speed control	+100% to -50% (DPC)
Power requirements	Two size AAA (LR03) alkaline batteries: 3 V DC
Dimensions	36.6x 112.3 x 21mm (1 ¹ / ₂ x 4 ¹ / ₂ x ²⁷ / ₃₂ in.) (w/h/d) (not incl. projecting parts and controls)
Mass	98 g (3.5 oz) (incl. batteries and a “Memory Stick”)
Supplied accessories	“Memory Stick”(ICD-BM1: 16MB x 1/ICD-BM1PRO: 16MB x 3) “Digital Voice Editor” (CD-ROM) x 1 Ear receiver x 1 USB connecting cable x 1 Carrying case x 1
Optional accessories	Stereo ear receiver MDR-EX71/ Active speaker SRS-T77/Electret condenser microphone ECM-DS70P, ECM-CS10/Audio connecting cable RK-134, RK-136/Memory Stick MSA-16AN (16 MB), MSA-32AN (32 MB), MSA-64AN (64 MB), MSA-128AN (128 MB)/PC Card Adaptor for Memory Stick MSAC-PC3/USB-compatible Memory Stick Reader/Writer MSAC-US70/ AC power adaptor AC-E30HG

Your dealer may not handle some of the above listed optional accessories. Please ask the dealer for detailed information.

Design and specifications are subject to change without notice.

Index to Parts and Controls

Refer to the pages indicated in parentheses for details.

Front

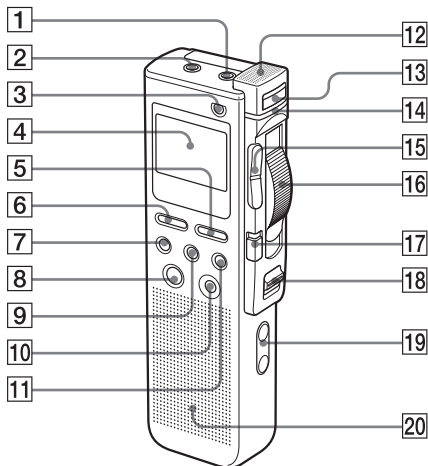

- | | |
|---|---|
| 1 MIC (microphone) (PLUG IN POWER) jack (18) | 12 Built-in microphone (14) |
| 2 Ⓛ (headphones) jack (16, 19, 21) | 13 NEW FILE button (15) |
| 3 ERASE button (29, 34) | 14 OPR (operation) indicator (14, 21) |
| 4 Display window (24) | 15 Jog lever ◀◀ (review/fast backward)/▶▶ (cue/fast forward) |
| 5 MENU button (49) | 16 Control key REC (record) / STOP/PLAY/B.SPACE |
| 6 DISPLAY button (26) | 17 DPC switch (22, 39) |
| 7 FOLDER button (13, 20) | 18 POWER ON/OFF switch (8, 13) |
| 8 ENTER button | 19 VOL (volume) +/- buttons (21) |
| 9 DIVIDE button (31) | 20 Speaker |
| 10 CANCEL button | |
| 11 PRIORITY button (36) | |

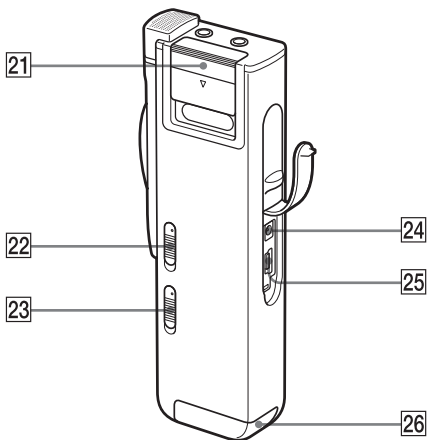

- 21** Memory Stick slot cover (10)
- 22** MIC SENS (microphone sensitivity) switch (17)
CONF(H) (conference, high)/DICT(L) (dictation, low)
- 23** VOR (voice operated recording) ON/OFF switch (16)
- 24** DC IN 3V jack (6)
- 25** USB connector (52)
- 26** Battery compartment (6)

Index

A

“ACCESS” message	11
Add, folders	33
Add, priority	36
Advanced VOR	16
Alarm	43

B

Battery life	7
Beep	51
Built-in microphone	14

C

Connecting, computer	52
Connecting, external microphone	18
Connecting, other equipment ..	19
Counter display	26
Cue	22
Current time display	27

D

Digital Voice Editor	52
Display mode	26
Display window	24
Dividing a message	31
DPC (Digital Pitch Control)	22, 39

E

Easy search	23, 51
Erase, folders	34
Erase, messages	28
Error messages	59
External microphone	18

F

Folder, adding/erasing	33
Folder, labeling	38
Folder, selecting	13, 20
Folder name	38
Format	47

L

Labeling folders	38
LP mode	7, 12, 50

M

Maximum number of messages	12, 62
Maximum recording time ..	12, 62
“Memory Stick”, format	47
“Memory Stick”, inserting	10
“Memory Stick”, notes on use ...	55
“Memory Stick”, types	11
“Memory Stick”, write-protect switch	55
Menu	49
Message, dividing	31
Message, erasing	28
Message, moving	35
Message, playback	20
Message, recording	12
Message name display	27
Message number	14, 20
Microphone, built-in	14
Microphone, connecting	18
Microphone, external	18
Microphone sensitivity	17, 24
Minimum recording unit	62
Monitoring recording	16
Moving a message	35

N		
NEW FILE	15	
O		
OPR indicator	14, 21	
Overwrite recording	15, 41	
P		
Playback	20	
Playback speed	39	
Plug in power	18	
POWER	8, 13	
Priority mark	36	
R		
Recorded date and time display	26	
Recording	12	
Recording as a new message ...	15	
Recording mode	7, 12, 50	
Recording with other equipment	19	
Remaining battery	7	
Remaining memory	17	
Remaining time display	26	
Repeat playback	23, 50	
Review	16, 22	
S		
Searching forward/backward .	22	
Setting the clock	8	
SP mode	7, 12, 50	
Specifications	63	
ST mode	7, 12, 50	
System limitations	61	
System requirements	53	
T		
Troubleshooting	56	
Turning on power	8, 13	
U		
USB cable	52	
Using the house current	6	
V		
VOR	16	

<http://www.sony.net/>



Printed on 100% recycled
paper using VOC (Volatile
Organic Compound)-free
vegetable oil based ink.

Printed in Japan
